

U-Wing Endmill **NEW**

중경도 가공용 U-윙 엔드밀

제품설명

- HRc30~50 중경도강, 금형강 가공용
- 내마모성과 윤활성에 탁월한 신규 코팅 적용
- 다양한 제원과 리브타입 확보를 통한 복잡한 금형가공에 탁월

제품특징

- HRc30~50 중경도강, 금형강 가공용 초경 엔드밀
- AlCrN계 박막적용을 통한 내마모성, 윤활성 향상
- 볼 엔드밀 공구의 인선강도 향상을 위한 소재 적용
- 고인성 소재 적용을 통한 플랫 엔드밀의 내치핑성 향상
- 복잡한 금형가공에 적합한 다양한 형상, 제원의 제품군 보유
- h5 샹크, 날경 및 래디우스 고정밀 공차 적용으로 정밀가공에 적합

인선처리 적용

- 초기 절입 시 발생하는 내치핑성 보완
- 내마모성 향상 및 안정적인 가공 유도

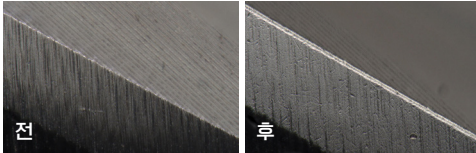

중경도용 모재 채택

- 소재 분리적용을 통한 공구 특성의 극대화, 범용 가공성 확대



S커브 계취 형상 채택

- 가공부하 분산을 통한 절삭성, 내마모성 향상

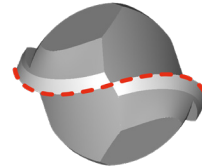

AlCrN base New Coating

- 신규 코팅 적용을 통한 내마모성과 내산화성 향상
- Cr 함유를 통한 윤활성 향상
- 마찰열에 대한 안정성 확보

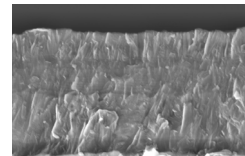

경쟁사 수명비교

▶ 2날 D12.0 볼 엔드밀

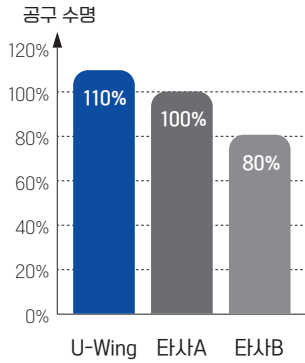

· 절삭조건 : Profiling / rpm : 8,340 / feed : 2,830 / ap : 0.18 / ae : 0.3 / Coolant : 습식

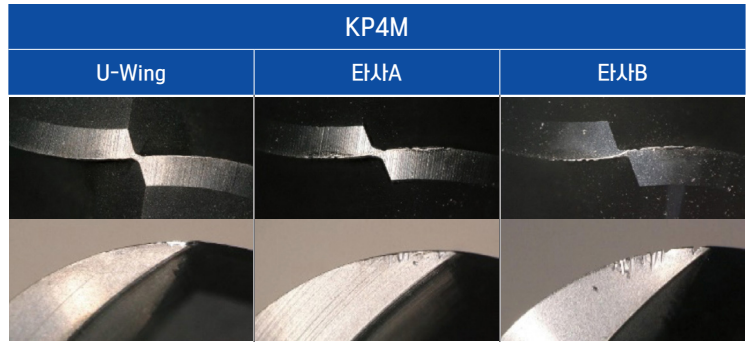
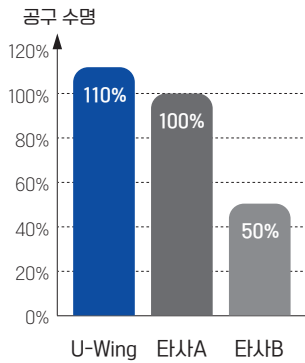

· 절삭조건 : Profiling / rpm : 8,040 / feed : 2,410 / ap : 0.18 / ae : 0.3 / Coolant : 습식

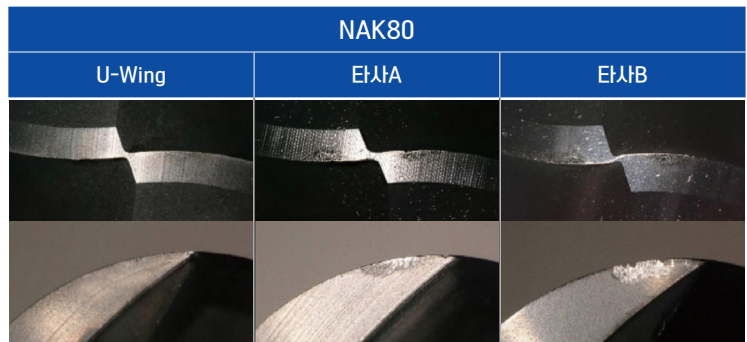
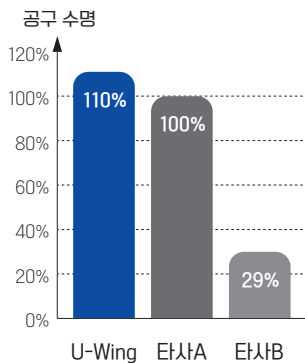

· 절삭조건 : Profiling / rpm : 7,128 / feed : 2,420 / ap : 0.18 / ae : 0.3 / Coolant : 습식

U-Wing Endmill **NEW**

중경도 가공용 U-윙 엔드밀

경쟁사 수명비교

▶ 4날 D6.0 볼 엔드밀

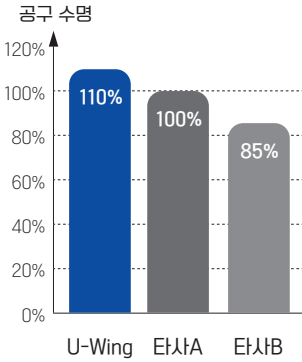

· 절삭조건 : Shouldering / rpm : 2,840 / feed : 340 / ap : 6 / ae : 0.3 / Coolant : 습식

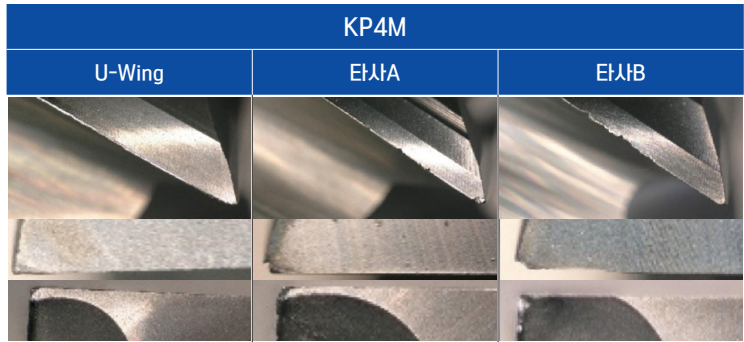
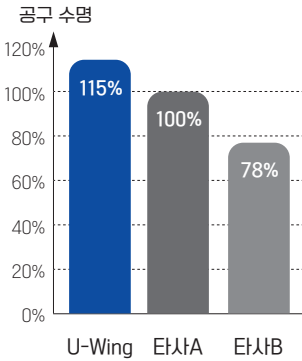

· 절삭조건 : Shouldering / rpm : 5,560 / feed : 660 / ap : 6 / ae : 0.3 / Coolant : 습식

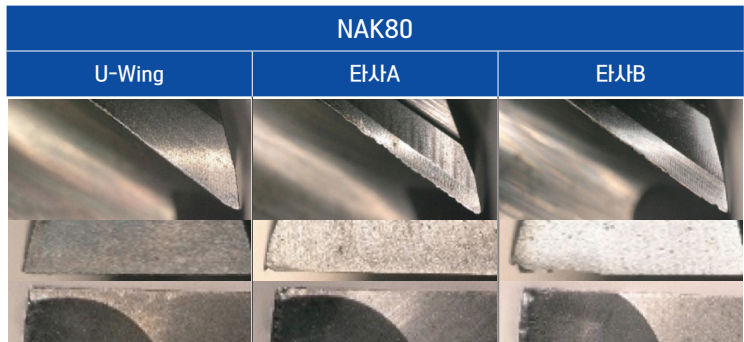
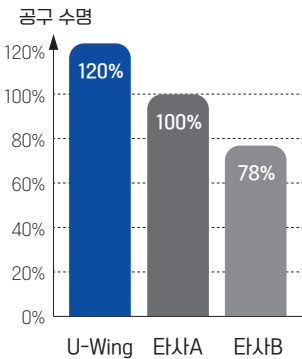

· 절삭조건 : Shouldering / rpm : 3,360 / feed : 400 / ap : 6 / ae : 0.3 / Coolant : 습식



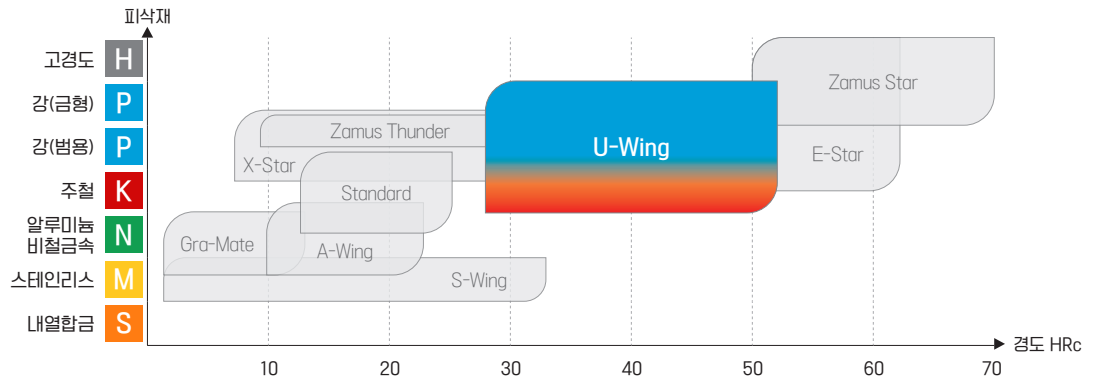









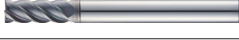





적용영역

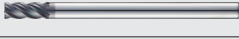
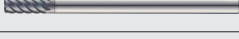
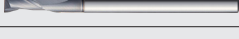
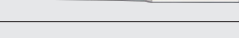
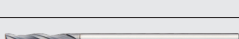
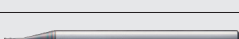
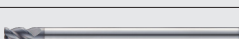

U-Wing Endmill NEW

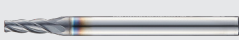
중경도 가공용 U-윙 엔드밀

목차

구분		제품번호	사진	품명	공구직경(DC)		페이지	
형상	날수				최소	최대		
스퀘어	2날	UE502		2날 스퀘어 엔드밀	0.1	25	183	
	4날	UE504		4날 스퀘어 엔드밀	0.8	25	185	
	4날	UE504H		4날 45도 헬릭스 스퀘어 엔드밀	1	20	186	
	6날	UE506		6날 스퀘어 엔드밀	6	25	187	
	2날	UE512		2날 롱 넥 스퀘어 엔드밀	0.1	12	188	
	4날	UE514		4날 롱 넥 스퀘어 엔드밀	1	12	191	
	2날	UE522		2날 스퀘어 엔드밀	1	25	193	
	4날	UE524		4날 스퀘어 엔드밀	1	25	196	
	4날	ULE504		4날 자동선반용 스퀘어 엔드밀	3	16	199	
	2날	UXE502		2날 강력절삭용 스퀘어 엔드밀	0.1	20	200	
	4날	UXE504		4날 강력절삭용 스퀘어 엔드밀	1	20	202	
	2날	UTE502		2날 테이퍼 스퀘어 엔드밀	0.3	10	204	
	4날	UTE504		4날 테이퍼 스퀘어 엔드밀	0.8	10	207	
	라디우스	2날	UR502		2날 라디우스 엔드밀	0.2	20	211
		4날	UR504		4날 라디우스 엔드밀	3	20	215
6날		UR506		6날 라디우스 엔드밀	6	20	217	
2날		UR512		2날 넥타입 라디우스 엔드밀	0.2	20	218	
2날		UR542		2날 테이퍼 넥 라디우스 엔드밀	0.2	4	225	
4날		UR544		4날 테이퍼 넥 라디우스 엔드밀	1	4	236	
4날		UXR504		4날 멀티 헬릭스 라디우스 엔드밀	1	20	245	
4날		UXR514		4날 멀티 헬릭스 넥 라디우스 엔드밀	1	20	248	
3날		UDR503		3날 더블 라디우스 엔드밀	6	20	254	
4날		USPM4		4날 고이송용 라디우스 엔드밀	1	20	255	
4날		UTR504		4날 테이퍼 라디우스 엔드밀	0.8	2.5	257	
볼		2날	UB502		2날 볼 엔드밀	0.1	25	262

구분		제품번호	사진	품명	공구직경(DC)		페이지
형상	날수				최소	최대	
볼	2날	UB502-P		2날 고정밀 볼 엔드밀	0.1	12	265
	3날	UB503		3날 볼 엔드밀	1	12	266
	4날	UB504		4날 볼 엔드밀	1	12	267
	2날	UB512		2날 롱 넥 볼 엔드밀	0.1	12	268
	2날	UB512 S6		2날 롱 넥 볼 엔드밀(자루경 6)	0.5	2	272
	2날	UB532		2날 롤러팁 스타일 볼 엔드밀	3	12	274
	2날	UB542		2날 테이퍼 넥 볼 엔드밀	0.1	12	275
	2날	UTB502		2날 테이퍼 볼 엔드밀	0.3	2	289
	2날	USB502		2날 스트레이트 넥 볼 엔드밀	3	20	292
러핑	3~5날	UF50		3~5날 챔퍼 피치 러핑 엔드밀	3	25	293
	3~5날	UF51		3~5날 파인 피치 러핑 엔드밀	3	25	294
	3~5날	UF51-H		3~5날 45도 헬릭스 파인 피치 러핑 엔드밀	3	25	295

U-Wing Endmill NEW

중경도 가공용 U-윙 엔드밀

품번체계

*정수로 표현되는 경우 소수점 이하는 생략합니다.

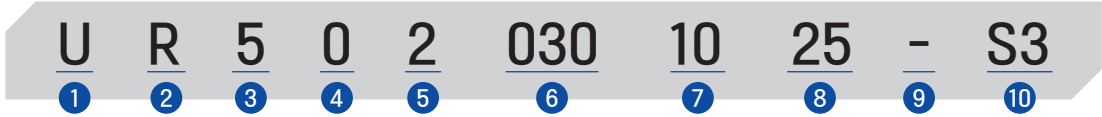

① 분류	② 형상 및 용도	③ 등급	④ 날부유형	⑤ 날수	⑥ 날경	⑦ 코너R	⑧ 넥장	⑨ 전장	⑩ 세부특성
U : U-Wing	E : 스퀘어	5 : Grade	0 : 일반	2 : 2날	0.1	0.05	0.2	35	P : 정밀공차
	R : 래디우스		1 : 넥	3 : 3날	~	~	~	~	S3~S6 : 자루경
	B : 볼		2 : 상크	4 : 4날	25	5	300	300	H : 하이 헬릭스
	SB : 스트레이트 볼		3 : 톨리팝	5 : 5날					
	SPM : 고이송		4 : 테이퍼 넥	6 : 6날					
	XE : 강력절삭용 스퀘어								
	XR : 멀티헬릭스 래디우스								
	TE : 테이퍼 스퀘어								
	TR : 테이퍼 래디우스								
	TB : 테이퍼 볼								
	DR : 더블 래디우스								
	F : 러핑								
	LE : 스퀘어(선반용)								

EX) 2날 / 날경 03 / 코너R 1.0 / 유효장 6mm / 자루경 4 / 50급 코너 래디우스 넥 타입 U-윙 엔드밀

UE502 2날 스퀘어 엔드밀

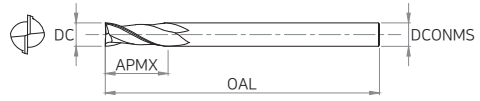
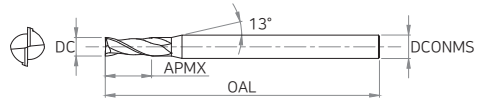

▶ 제품허용공차

날경(DC)		자루경
∅0.1 ~ ∅6	0 ~ -0.012	h5
∅6.5 ~ ∅25	0 ~ -0.015	

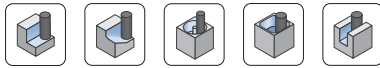

품목코드	DC	APMX	OAL	DCONMS
	날경	날장	전장	자루경
UE502 001S3	0.1	0.2	40	3
UE502 001	0.1	0.2	40	4
UE502 0015	0.15	0.3	40	4
UE502 002S3	0.2	0.4	40	3
UE502 002	0.2	0.4	40	4
UE502 0025	0.25	0.5	40	4
UE502 003S3	0.3	0.6	40	3
UE502 003	0.3	0.6	40	4
UE502 0035	0.35	0.7	40	4
UE502 004S3	0.4	0.8	40	3
UE502 004	0.4	0.8	40	4
UE502 0045	0.45	0.9	40	4
UE502 005S3	0.5	1	40	3
UE502 005	0.5	1	40	4
UE502 0055	0.55	1.1	40	4
UE502 006S3	0.6	1.2	40	3
UE502 006	0.6	1.2	40	4
UE502 0065	0.65	1.3	40	4
UE502 007S3	0.7	1.4	40	3
UE502 007	0.7	1.4	40	4

품목코드	DC	APMX	OAL	DCONMS
	날경	날장	전장	자루경
UE502 0075	0.75	1.5	40	4
UE502 008S3	0.8	1.6	40	3
UE502 008	0.8	1.6	40	4
UE502 0085	0.85	1.7	40	4
UE502 009S3	0.9	1.8	40	3
UE502 009	0.9	1.8	40	4
UE502 0095	0.95	2	40	4
UE502 010S3	1	2.5	50	3
UE502 010S4	1	2.5	50	4
UE502 010	1	2.5	50	6
UE502 011S4	1.1	3	50	4
UE502 012S3	1.2	3	50	3
UE502 012S4	1.2	3	50	4
UE502 012	1.2	3	50	6
UE502 013S4	1.3	3	50	4
UE502 014S4	1.4	4	50	4
UE502 015S3	1.5	4	50	3
UE502 015S4	1.5	4	50	4
UE502 015	1.5	4	50	6
UE502 016S4	1.6	4	50	4

▶ 적용 피삭재

○ : 적합 ◎ : 매우 적합

H		P			K	N			M	S
열처리강		탄소강	합금강	프리하트강	주철	동	흑연	알루미늄	스테인리스	내열합금
SKD61 ~HRc55	SKD11 HRc55~	~HB225	HB225 ~325	HRc30~50	~FCD500					
○		○	◎	◎	○					

UE502 2날 스퀘어 엔드밀

Endmill

종류	품목코드	DC	APMX	OAL	DCONMS	품목코드	DC	APMX	OAL	DCONMS
		날경	날장	전장	자루경		날경	날장	전장	자루경
Zamus Star	UE502 017S4	1.7	4	50	4	UE502 065	6.5	18	60	8
	UE502 018S4	1.8	5	50	4	UE502 070	7	20	60	8
	UE502 019S4	1.9	5	50	4	UE502 075	7.5	20	60	8
	UE502 020S3	2	6	50	3	UE502 080	8	20	70	8
E-Star	UE502 020S4	2	6	50	4	UE502 085	8.5	22	70	10
	UE502 020	2	6	50	6	UE502 090	9	22	70	10
	UE502 021S4	2.1	6	50	4	UE502 095	9.5	24	70	10
	UE502 022S4	2.2	6	50	4	UE502 100	10	25	75	10
U-Wing	UE502 023S4	2.3	6	50	4	UE502 105	10.5	26	75	12
	UE502 024S4	2.4	6	50	4	UE502 110	11	30	75	12
	UE502 025S3	2.5	7	50	3	UE502 115	11.5	30	80	12
	UE502 025	2.5	7	50	6	UE502 120	12	30	80	12
Zamus Thunder	UE502 025S4	2.5	8	50	4	UE502 130	13	35	100	12
	UE502 026S4	2.6	8	50	4	UE502 140S16	14	35	100	16
	UE502 027S4	2.7	8	50	4	UE502 140	14	35	100	14
	UE502 028S4	2.8	8	50	4	UE502 140S12	14	35	100	12
X-Star	UE502 029S4	2.9	8	50	4	UE502 150	15	38	100	16
	UE502 030S3	3	8	50	3	UE502 160	16	40	100	16
	UE502 030S4	3	8	50	4	UE502 170	17	42	100	16
	UE502 030	3	8	50	6	UE502 180	18	45	100	18
S-Wing	UE502 035S4	3.5	10	50	4	UE502 180S16	18	45	100	16
	UE502 035	3.5	10	50	6	UE502 190	19	45	100	20
	UE502 040080S4	4	10	80	4	UE502 200	20	45	100	20
	UE502 040S4	4	10	50	4	UE502 210	21	45	100	20
A-Wing	UE502 040	4	10	50	6	UE502 220	22	45	100	20
	UE502 045	4.5	14	50	6	UE502 230	23	50	120	25
	UE502 050	5	15	60	6	UE502 240	24	50	120	25
	UE502 055	5.5	15	60	6	UE502 250	25	50	120	25
Standard	UE502 060	6	15	60	6					

Copper
-Mate

Gra
-Mate

▶ 적용 피삭재

○ : 적합 ◎ : 매우 적합

H		P			K	N			M	S
열처리강		탄소강	합금강	프리하든강	주철	동	흑연	알루미늄	스테인리스	내열합금
SKD61 ~HRc55	SKD11 HRc55~	~HB225	HB225 ~325	HRc30~50	~FCD500					
○		○	◎	◎	○					

UE504 4날 스퀘어 엔드밀

Endmill

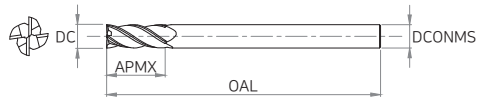
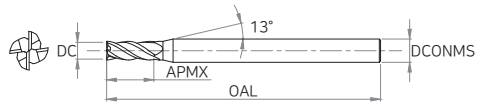

▶ 제품허용공차

날경(DC)		자루경
φ0.8 ~ φ25	0 ~ -0.03	h5

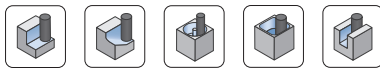

품목코드	DC	APMX	OAL	DCONMS
	날경	날장	전장	자루경
UE504 008	0.8	1.6	40	4
UE504 009	0.9	1.8	40	4
UE504 010	1	2.5	50	6
UE504 012	1.2	3	50	6
UE504 015	1.5	4	50	6
UE504 020	2	6	50	6
UE504 025	2.5	7	50	6
UE504 030	3	8	50	6
UE504 035	3.5	10	50	6
UE504 040	4	10	50	6
UE504 045	4.5	14	50	6
UE504 050	5	15	60	6
UE504 055	5.5	15	60	6
UE504 060	6	15	60	6
UE504 065	6.5	18	60	8
UE504 070	7	20	60	8
UE504 075	7.5	20	60	8
UE504 080	8	20	70	8
UE504 085	8.5	22	70	10
UE504 090	9	22	70	10
UE504 095	9.5	24	70	10
UE504 100	10	25	75	10

품목코드	DC	APMX	OAL	DCONMS
	날경	날장	전장	자루경
UE504 105	10.5	26	75	12
UE504 110	11	30	75	12
UE504 115	11.5	30	80	12
UE504 120	12	30	80	12
UE504 125	12.5	30	80	12
UE504 130	13	35	100	12
UE504 140	14	35	100	16
UE504 140S14	14	35	100	14
UE504 140S12	14	35	100	12
UE504 150	15	38	100	16
UE504 160	16	40	100	16
UE504 170	17	42	100	16
UE504 180	18	45	100	18
UE504 180S16	18	45	100	16
UE504 190	19	45	100	20
UE504 200	20	45	100	20
UE504 210	21	45	100	20
UE504 220	22	45	100	20
UE504 230	23	50	120	25
UE504 240	24	50	120	25
UE504 250	25	50	120	25

Zamus Star

E-Star

U-Wing

Zamus Thunder

X-Star

S-Wing

A-Wing

Standard

Copper-Mate

Gra-Mate

▶ 적용 피삭재

○ : 적합 ◎ : 매우 적합

H		P			K	N			M	S
열처리강		탄소강	합금강	프리하든강	주철	동	흑연	알루미늄	스테인리스	내열합금
SKD61 ~HRc55	SKD11 HRc55~	~HB225	HB225 ~325	HRc30~50	~FCD500					
○		○	◎	◎	○					

UE504H

4날 45도 헬릭스 스퀘어 엔드밀

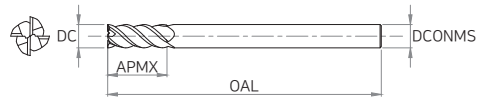
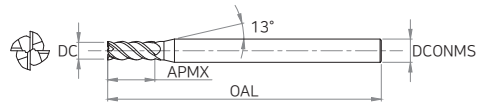

▶ 제품허용공차

날경(DC)		자루경
Ø1 ~ Ø20	0 ~ -0.03	h5

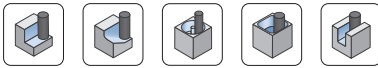

품목코드	DC	APMX	OAL	DCONMS	품목코드	DC	APMX	OAL	DCONMS
	날경	날장	전장	자루경		날경	날장	전장	자루경
UE504H 010	1	2.5	50	6	UE504H 06030	6	30	80	6
UE504H 01004	1	4	60	6	UE504H 080	8	20	70	8
UE504H 01006	1	6	60	6	UE504H 08030	8	30	80	8
UE504H 015	1.5	4	50	6	UE504H 08035	8	35	90	8
UE504H 01506	1.5	6	60	6	UE504H 08040	8	40	90	8
UE504H 01508	1.5	8	60	6	UE504H 100	10	25	75	10
UE504H 020	2	6	50	6	UE504H 10030	10	30	80	10
UE504H 02008	2	8	60	6	UE504H 10040	10	40	90	10
UE504H 02010	2	10	60	6	UE504H 10050	10	50	100	10
UE504H 030	3	8	50	6	UE504H 120	12	30	80	12
UE504H 03010	3	10	70	6	UE504H 12040	12	40	90	12
UE504H 03012	3	12	70	6	UE504H 12050	12	50	100	12
UE504H 03016	3	16	70	6	UE504H 12060	12	60	110	12
UE504H 040	4	10	50	6	UE504H 160	16	40	100	16
UE504H 04012	4	12	70	6	UE504H 16050	16	50	110	16
UE504H 04016	4	16	70	6	UE504H 16060	16	60	120	16
UE504H 04020	4	20	70	6	UE504H 160110	16	110	200	16
UE504H 050	5	15	50	6	UE504H 200	20	45	100	20
UE504H 05030	5	30	80	6	UE504H 20060	20	60	120	20
UE504H 060	6	15	60	6	UE504H 20070	20	70	130	20
UE504H 06020	6	20	70	6	UE504H 200110	20	110	200	20

▶ 적용 피삭재

○ : 적합 ◎ : 매우 적합

H		P			K	N			M	S
열처리강		탄소강	합금강	프리하든강	주철	동	흑연	알루미늄	스테인리스	내열합금
SKD61 ~HRc55	SKD11 HRc55~	~HB225	HB225 ~325	HRc30~50	~FCD500					
○		○	◎	◎	○					

UE506 6날 스퀘어 엔드밀

Endmill

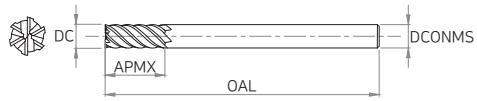
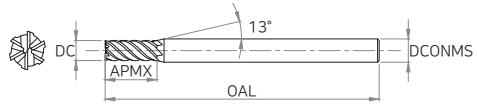

▶ 제품허용공차

날경(DC)		자루경
φ6 ~ φ25	0 ~ -0.03	h5

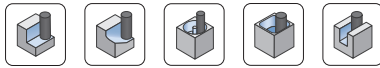

CARBIDE
AlCrN
6
45° HELIX
절삭조건 P.682

품목코드	DC	APMX	OAL	DCONMS
	날경	날장	전장	자루경
UE506 060	6	15	60	6
UE506 06020	6	20	70	6
UE506 06030110	6	30	110	6
UE506 06030	6	30	80	6
UE506 070	7	18	60	8
UE506 080	8	20	70	8
UE506 08030	8	30	80	8
UE506 08035	8	35	90	8
UE506 08040130	8	40	130	8
UE506 08040	8	40	90	8
UE506 090	9	22	70	10
UE506 100	10	25	75	10
UE506 10030	10	30	80	10
UE506 10040	10	40	90	10
UE506 10050150	10	50	150	10
UE506 10050	10	50	100	10
UE506 110	11	26	75	12
UE506 120	12	30	80	12
UE506 12040	12	40	90	12
UE506 12050	12	50	100	12

품목코드	DC	APMX	OAL	DCONMS
	날경	날장	전장	자루경
UE506 12060150	12	60	150	12
UE506 12060	12	60	110	12
UE506 130	13	32	85	14
UE506 140	14	32	85	14
UE506 160	16	40	100	16
UE506 16050	16	50	110	16
UE506 16060	16	60	120	16
UE506 16090	16	90	150	16
UE506 160110250	16	110	250	16
UE506 160110	16	110	200	16
UE506 180	18	44	100	18
UE506 200	20	45	100	20
UE506 20060	20	60	120	20
UE506 20070	20	70	130	20
UE506 200110300	20	110	300	20
UE506 200110250	20	110	250	20
UE506 200110	20	110	200	20
UE506 250	25	50	120	25
UE506 251	25	92	180	25

Zamus Star

E-Star

U-Wing

Zamus Thunder

X-Star

S-Wing

A-Wing

Standard

Copper-Mate

Gra-Mate

▶ 적용 피삭재

○ : 적합 ◎ : 매우 적합

H		P			K	N			M	S
열처리강		탄소강	합금강	프리하트강	주철	동	흑연	알루미늄	스테인리스	내열합금
SKD61 ~HRc55	SKD11 HRc55~	~HB225	HB225 ~325	HRc30~50	~FCD500					
○		○	◎	◎	○					

UE512 2날 롱 넥 스퀘어 엔드밀

Endmill

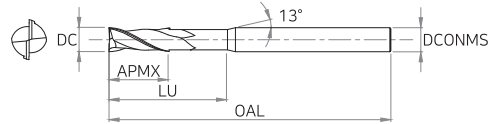
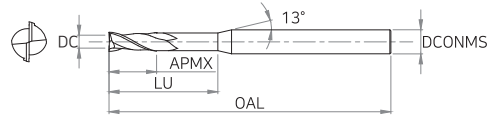

▶ 제품허용공차

날경(DC)		자루경
∅0.1 ~ ∅6	0 ~ -0.012	
∅8 ~ ∅12	0 ~ -0.015	

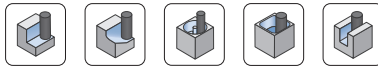

품목코드	DC	APMX	LU	OAL	DCONMS	품목코드	DC	APMX	LU	OAL	DCONMS
	날경	날장	유효장	전장	자루경		날경	날장	유효장	전장	자루경
UE512 001003	0.1	0.15	0.3	40	4	UE512 00501	0.5	0.7	1	45	4
UE512 001005	0.1	0.15	0.5	40	4	UE512 005015	0.5	0.7	1.5	45	4
UE512 00101	0.1	0.15	1	40	4	UE512 00502	0.5	0.7	2	45	4
UE512 002005	0.2	0.3	0.5	40	4	UE512 005025	0.5	0.7	2.5	45	4
UE512 00201	0.2	0.3	1	40	4	UE512 00503	0.5	0.7	3	45	4
UE512 002015	0.2	0.3	1.5	40	4	UE512 00504	0.5	0.7	4	45	4
UE512 00202	0.2	0.3	2	40	4	UE512 00505	0.5	0.7	5	45	4
UE512 00301	0.3	0.5	1	40	4	UE512 00506	0.5	0.7	6	45	4
UE512 003015	0.3	0.5	1.5	40	4	UE512 00508	0.5	0.7	8	45	4
UE512 00302	0.3	0.5	2	40	4	UE512 00510	0.5	0.7	10	45	4
UE512 003025	0.3	0.5	2.5	40	4	UE512 00512	0.5	0.7	12	45	4
UE512 00303	0.3	0.5	3	40	4	UE512 00514	0.5	0.7	14	45	4
UE512 00304	0.3	0.5	4	40	4	UE512 00516	0.5	0.7	16	45	4
UE512 00305	0.3	0.5	5	40	4	UE512 00602	0.6	0.9	2	45	4
UE512 00401	0.4	0.6	1	40	4	UE512 00603	0.6	0.9	3	45	4
UE512 004015	0.4	0.6	1.5	40	4	UE512 00604	0.6	0.9	4	45	4
UE512 00402	0.4	0.6	2	40	4	UE512 00605	0.6	0.9	5	45	4
UE512 004025	0.4	0.6	2.5	40	4	UE512 00606	0.6	0.9	6	45	4
UE512 00403	0.4	0.6	3	40	4	UE512 00608	0.6	0.9	8	45	4
UE512 00404	0.4	0.6	4	40	4	UE512 00610	0.6	0.9	10	45	4
UE512 00405	0.4	0.6	5	40	4	UE512 00612	0.6	0.9	12	45	4
UE512 00406	0.4	0.6	6	40	4	UE512 00614	0.6	0.9	14	45	4
UE512 00408	0.4	0.6	8	40	4	UE512 00616	0.6	0.9	16	45	4
UE512 00410	0.4	0.6	10	40	4	UE512 00702	0.7	1.2	2	45	4

▶ 적용 피삭재

○ : 적합 ◎ : 매우 적합

H		P			K	N		M	S	
열처리강		탄소강	합금강	프리하든강	주철	동	흑연	알루미늄	스테인리스	내열합금
SKD61 ~HRc55	SKD11 HRc55~	~HB225	HB225 ~325	HRc30~50	~FCD500					
○		○	◎	◎	○					

UE512 2날 롱 넥 스퀘어 엔드밀

Endmill

품목코드	DC	APMX	LU	OAL	DCONMS	품목코드	DC	APMX	LU	OAL	DCONMS
	날경	날장	유효장	전장	자루경		날경	날장	유효장	전장	자루경
UE512 00704	0.7	1.2	4	45	4	UE512 01210	1.2	1.8	10	50	4
UE512 00706	0.7	1.2	6	45	4	UE512 01212	1.2	1.8	12	50	4
UE512 00708	0.7	1.2	8	45	4	UE512 01214	1.2	1.8	14	50	4
UE512 00710	0.7	1.2	10	45	4	UE512 01216	1.2	1.8	16	50	4
UE512 00712	0.7	1.2	12	45	4	UE512 01220	1.2	1.8	20	50	4
UE512 00802	0.8	1.2	2	45	4	UE512 01226	1.2	1.8	26	60	4
UE512 00803	0.8	1.2	3	45	4	UE512 01230	1.2	1.8	30	70	4
UE512 00804	0.8	1.2	4	45	4	UE512 01406	1.4	2.1	6	50	4
UE512 00805	0.8	1.2	5	45	4	UE512 01408	1.4	2.1	8	50	4
UE512 00806	0.8	1.2	6	45	4	UE512 01410	1.4	2.1	10	50	4
UE512 00808	0.8	1.2	8	45	4	UE512 01414	1.4	2.1	14	50	4
UE512 00810	0.8	1.2	10	45	4	UE512 01416	1.4	2.1	16	50	4
UE512 00812	0.8	1.2	12	45	4	UE512 01420	1.4	2.1	20	50	4
UE512 00814	0.8	1.2	14	45	4	UE512 01504	1.5	2.3	4	50	4
UE512 00816	0.8	1.2	16	45	4	UE512 01505	1.5	2.3	5	50	4
UE512 00820	0.8	1.2	20	45	4	UE512 01506	1.5	2.3	6	50	4
UE512 00906	0.9	1.3	6	45	4	UE512 01507	1.5	2.3	7	50	4
UE512 00908	0.9	1.3	8	45	4	UE512 01508	1.5	2.3	8	50	4
UE512 00910	0.9	1.3	10	45	4	UE512 01510	1.5	2.3	10	50	4
UE512 01002	1	1.5	2	50	4	UE512 01512	1.5	2.3	12	50	4
UE512 01003	1	1.5	3	50	4	UE512 01514	1.5	2.3	14	50	4
UE512 01004	1	1.5	4	50	4	UE512 01516	1.5	2.3	16	50	4
UE512 01005	1	1.5	5	50	4	UE512 01518	1.5	2.3	18	50	4
UE512 01006	1	1.5	6	50	4	UE512 01520	1.5	2.3	20	50	4
UE512 01007	1	1.5	7	50	4	UE512 01522	1.5	2.3	22	60	4
UE512 01008	1	1.5	8	50	4	UE512 01526	1.5	2.3	26	60	4
UE512 01010	1	1.5	10	50	4	UE512 01530	1.5	2.3	30	70	4
UE512 01012	1	1.5	12	50	4	UE512 01608	1.6	2.3	8	50	4
UE512 01014	1	1.5	14	50	4	UE512 01610	1.6	2.3	10	50	4
UE512 01016	1	1.5	16	50	4	UE512 01612	1.6	2.3	12	50	4
UE512 01018	1	1.5	18	50	4	UE512 01616	1.6	2.3	16	50	4
UE512 01020	1	1.5	20	50	4	UE512 01620	1.6	2.3	20	50	4
UE512 01022	1	1.5	22	60	4	UE512 01808	1.8	2.7	8	50	4
UE512 01026	1	1.5	26	60	4	UE512 01810	1.8	2.7	10	50	4
UE512 01030	1	1.5	30	70	4	UE512 01812	1.8	2.7	12	50	4
UE512 01040	1	1.5	40	80	4	UE512 01816	1.8	2.7	16	50	4
UE512 01050	1	1.5	50	100	4	UE512 01820	1.8	2.7	20	50	4
UE512 01204	1.2	1.8	4	50	4	UE512 02006	2	3	6	50	4
UE512 01206	1.2	1.8	6	50	4	UE512 02008	2	3	8	50	4
UE512 01208	1.2	1.8	8	50	4	UE512 02010	2	3	10	50	4

Zamus Star
E-Star
U-Wing
Zamus Thunder
X-Star
S-Wing
A-Wing
Standard
Copper-Mate
Gra-Mate

▶ 적용 피삭재

○ : 적합 ◎ : 매우 적합

H		P			K	N			M	S
열처리강		탄소강	합금강	프리하트강	주철	동	흑연	알루미늄	스테인리스	내열합금
SKD61 ~HRc55	SKD11 HRc55~	~HB225	HB225 ~325	HRc30~50	~FCD500					
○		○	◎	◎	○					

UE512 2날 롱 넥 스퀘어 엔드밀

Endmill

품목코드	DC	APMX	LU	OAL	DCONMS	품목코드	DC	APMX	LU	OAL	DCONMS
	날경	날장	유효장	전장	자루경		날경	날장	유효장	전장	자루경
UE512 02012	2	3	12	50	4	UE512 03045	3	4.5	45	90	6
UE512 02014	2	3	14	50	4	UE512 03050	3	4.5	50	100	6
UE512 02016	2	3	16	50	4	UE512 03060	3	4.5	60	100	6
UE512 02018	2	3	18	50	4	UE512 04008	4	6	8	50	6
UE512 02020	2	3	20	50	4	UE512 04010	4	6	10	50	6
UE512 02022	2	3	22	60	4	UE512 04012	4	6	12	50	6
UE512 02026	2	3	26	60	4	UE512 04014	4	6	14	60	6
UE512 02030	2	3	30	70	4	UE512 04016	4	6	16	60	6
UE512 02035	2	3	35	70	4	UE512 04018	4	6	18	60	6
UE512 02040	2	3	40	80	4	UE512 04020	4	6	20	60	6
UE512 02045	2	3	45	90	4	UE512 04022	4	6	22	65	6
UE512 02050	2	3	50	100	4	UE512 04026	4	6	26	65	6
UE512 02060	2	3	60	110	4	UE512 04030	4	6	30	70	6
UE512 02508	2.5	4	8	50	4	UE512 04035	4	6	35	70	6
UE512 02510	2.5	4	10	50	4	UE512 04040	4	6	40	80	6
UE512 02512	2.5	4	12	50	4	UE512 04045	4	6	45	90	6
UE512 02514	2.5	4	14	50	4	UE512 04050	4	6	50	100	6
UE512 02516	2.5	4	16	50	4	UE512 04060	4	6	60	100	6
UE512 02518	2.5	4	18	50	4	UE512 05016	5	8	16	60	6
UE512 02520	2.5	4	20	50	4	UE512 05020	5	8	20	60	6
UE512 02522	2.5	4	22	60	4	UE512 05026	5	8	26	65	6
UE512 02526	2.5	4	26	60	4	UE512 05030	5	8	30	70	6
UE512 02530	2.5	4	30	70	4	UE512 05035	5	8	35	75	6
UE512 02535	2.5	4	35	70	4	UE512 05040	5	8	40	80	6
UE512 02540	2.5	4	40	80	4	UE512 05050	5	8	50	90	6
UE512 02545	2.5	4	45	90	4	UE512 05060	5	8	60	100	6
UE512 02550	2.5	4	50	100	4	UE512 06015	6	9	15	60	6
UE512 03006	3	4.5	6	50	6	UE512 06020	6	9	20	60	6
UE512 03008	3	4.5	8	50	6	UE512 06030	6	9	30	70	6
UE512 03010	3	4.5	10	50	6	UE512 06032	6	9	32	90	6
UE512 03012	3	4.5	12	50	6	UE512 08025	8	12	25	70	8
UE512 03014	3	4.5	14	60	6	UE512 08030	8	12	30	80	8
UE512 03016	3	4.5	16	60	6	UE512 08042	8	12	42	100	8
UE512 03018	3	4.5	18	60	6	UE512 10030	10	15	30	75	10
UE512 03020	3	4.5	20	60	6	UE512 10035	10	15	35	80	10
UE512 03022	3	4.5	22	65	6	UE512 10045	10	15	45	100	10
UE512 03026	3	4.5	26	65	6	UE512 12035	12	20	35	80	12
UE512 03030	3	4.5	30	70	6	UE512 12040	12	20	40	90	12
UE512 03035	3	4.5	35	70	6	UE512 12050	12	20	50	110	12
UE512 03040	3	4.5	40	80	6						

▶ 적용 피삭재

○ : 적합 ◎ : 매우 적합

H		P			K	N			M	S
열처리강		탄소강	합금강	프리하든강	주철	동	흑연	알루미늄	스테인리스	내열합금
SKD61 ~HRc55	SKD11 HRc55~	~HB225	HB225 ~325	HRc30~50	~FCD500					
○		○	◎	◎	○					

UE514 4날 롱 넥 스퀘어 엔드밀

Endmill

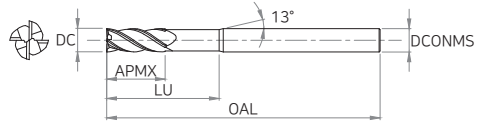
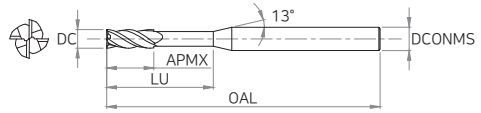

▶ 제품허용공차

날경(DC)		자루경
Ø1 ~ Ø12	0 ~ -0.03	h5

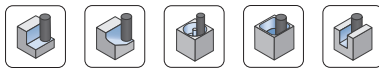

CARBIDE AICrN 35° HELIX 절삭조건 P.688

품목코드	DC	APMX	LU	OAL	DCONMS
	날경	날장	유효장	전장	자루경
UE514 01002	1	1.5	2	50	4
UE514 01003	1	1.5	3	50	4
UE514 01004	1	1.5	4	50	4
UE514 01005	1	1.5	5	50	4
UE514 01006	1	1.5	6	50	4
UE514 01007	1	1.5	7	50	4
UE514 01008	1	1.5	8	50	4
UE514 01010	1	1.5	10	50	4
UE514 01012	1	1.5	12	50	4
UE514 01014	1	1.5	14	50	4
UE514 01016	1	1.5	16	50	4
UE514 01018	1	1.5	18	50	4
UE514 01020	1	1.5	20	50	4
UE514 01022	1	1.5	22	60	4
UE514 01026	1	1.5	26	60	4
UE514 01030	1	1.5	30	70	4
UE514 01040	1	1.5	40	80	4
UE514 01050	1	1.5	50	100	4
UE514 01204	1.2	1.8	4	50	4
UE514 01206	1.2	1.8	6	50	4
UE514 01208	1.2	1.8	8	50	4
UE514 01210	1.2	1.8	10	50	4
UE514 01212	1.2	1.8	12	50	4

품목코드	DC	APMX	LU	OAL	DCONMS
	날경	날장	유효장	전장	자루경
UE514 01214	1.2	1.8	14	50	4
UE514 01216	1.2	1.8	16	50	4
UE514 01220	1.2	1.8	20	50	4
UE514 01226	1.2	1.8	26	60	4
UE514 01230	1.2	1.8	30	70	4
UE514 01504	1.5	2.3	4	50	4
UE514 01505	1.5	2.3	5	50	4
UE514 01506	1.5	2.3	6	50	4
UE514 01507	1.5	2.3	7	50	4
UE514 01508	1.5	2.3	8	50	4
UE514 01510	1.5	2.3	10	50	4
UE514 01512	1.5	2.3	12	50	4
UE514 01514	1.5	2.3	14	50	4
UE514 01516	1.5	2.3	16	50	4
UE514 01518	1.5	2.3	18	50	4
UE514 01520	1.5	2.3	20	50	4
UE514 01522	1.5	2.3	22	60	4
UE514 01526	1.5	2.3	26	60	4
UE514 01530	1.5	2.3	30	70	4
UE514 02006	2	3	6	50	4
UE514 02008	2	3	8	50	4
UE514 02010	2	3	10	50	4
UE514 02012	2	3	12	50	4

▶ 적용 피삭재

○ : 적합 ◎ : 매우 적합

H		P			K	N			M	S
열처리강		탄소강	합금강	프리하든강	주철	동	흑연	알루미늄	스테인리스	내열합금
SKD61 ~HRc55	SKD11 HRc55~	~HB225	HB225 ~325	HRc30~50	~FCD500					
○		○	◎	◎	○					

Zamus Star
E-Star
U-Wing
Zamus Thunder
X-Star
S-Wing
A-Wing
Standard
Copper-Mate
Gra-Mate

UE514 4날 롱 넥 스퀘어 엔드밀

Endmill

	품목코드	DC	APMX	LU	OAL	DCONMS	품목코드	DC	APMX	LU	OAL	DCONMS
		날경	날장	유효장	전장	자루경		날경	날장	유효장	전장	자루경
Zamus Star	UE514 02014	2	3	14	50	4	UE514 03045	3	4.5	45	90	6
	UE514 02016	2	3	16	50	4	UE514 03050	3	4.5	50	100	6
	UE514 02018	2	3	18	50	4	UE514 03060	3	4.5	60	100	6
	UE514 02020	2	3	20	50	4	UE514 04008	4	4.5	8	50	6
	UE514 02022	2	3	22	60	4	UE514 04010	4	4.5	10	50	6
E-Star	UE514 02026	2	3	26	60	4	UE514 04012	4	4.5	12	50	6
	UE514 02030	2	3	30	70	4	UE514 04014	4	4.5	14	60	6
	UE514 02035	2	3	35	70	4	UE514 04016	4	4.5	16	60	6
	UE514 02040	2	3	40	80	4	UE514 04018	4	4.5	18	60	6
	UE514 02045	2	3	45	90	4	UE514 04020	4	4.5	20	60	6
U-Wing	UE514 02050	2	3	50	100	4	UE514 04022	4	4.5	22	65	6
	UE514 02060	2	3	60	110	4	UE514 04026	4	4.5	26	65	6
	UE514 02508	2.5	4	8	50	4	UE514 04030	4	4.5	30	70	6
	UE514 02510	2.5	4	10	50	4	UE514 04035	4	4.5	35	70	6
	UE514 02512	2.5	4	12	50	4	UE514 04040	4	4.5	40	80	6
Zamus Thunder	UE514 02514	2.5	4	14	50	4	UE514 04045	4	4.5	45	90	6
	UE514 02516	2.5	4	16	50	4	UE514 04050	4	4.5	50	100	6
	UE514 02518	2.5	4	18	50	4	UE514 04060	4	4.5	60	100	6
	UE514 02520	2.5	4	20	50	4	UE514 05016	5	8	16	60	6
	UE514 02522	2.5	4	22	60	4	UE514 05020	5	8	20	60	6
X-Star	UE514 02526	2.5	4	26	60	4	UE514 05026	5	8	26	65	6
	UE514 02530	2.5	4	30	70	4	UE514 05030	5	8	30	70	6
	UE514 02535	2.5	4	35	70	4	UE514 05035	5	8	35	75	6
	UE514 02540	2.5	4	40	80	4	UE514 05040	5	8	40	80	6
	UE514 02545	2.5	4	45	90	4	UE514 05050	5	8	50	90	6
S-Wing	UE514 02550	2.5	4	50	100	4	UE514 05060	5	8	60	100	6
	UE514 03006	3	4.5	6	50	6	UE514 06015	6	9	15	60	6
	UE514 03008	3	4.5	8	50	6	UE514 06020	6	9	20	60	6
	UE514 03010	3	4.5	10	50	6	UE514 06030	6	9	30	70	6
	UE514 03012	3	4.5	12	50	6	UE514 06032	6	9	32	90	6
A-Wing	UE514 03014	3	4.5	14	60	6	UE514 08025	8	12	25	70	8
	UE514 03016	3	4.5	16	60	6	UE514 08030	8	12	30	80	8
	UE514 03018	3	4.5	18	60	6	UE514 08042	8	12	42	100	8
	UE514 03020	3	4.5	20	60	6	UE514 10030	10	15	30	75	10
	UE514 03022	3	4.5	22	65	6	UE514 10035	10	15	35	80	10
Standard	UE514 03026	3	4.5	26	65	6	UE514 10045	10	15	45	100	10
	UE514 03030	3	4.5	30	70	6	UE514 12035	12	20	35	80	12
	UE514 03035	3	4.5	35	70	6	UE514 12040	12	20	40	90	12
	UE514 03040	3	4.5	40	80	6	UE514 12050	12	20	50	110	12

▶ 적용 피삭재

○ : 적합 ◎ : 매우 적합

H		P			K	N			M	S
열처리강		탄소강	합금강	프리하든강	주철	동	흑연	알루미늄	스테인리스	내열합금
SKD61 ~HRc55	SKD11 HRc55~	~HB225	HB225 ~325	HRc30~50	~FCD500					
○		○	◎	◎	○					

UE522 2날 스퀘어 엔드밀

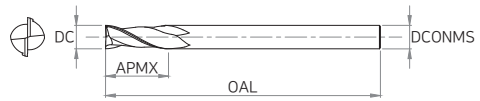
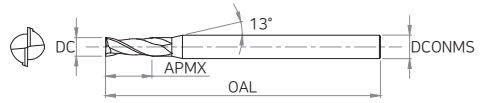

▶ 제품허용공차

날경(DC)		자루경
Ø1 ~ Ø6	0 ~ -0.012	h5
Ø7 ~ Ø25	0 ~ -0.015	

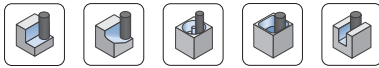

품목코드	DC	APMX	OAL	DCONMS
	날경	날장	전장	자루경
UE522 01003	1	3	60	6
UE522 01004	1	4	60	6
UE522 01005	1	5	60	6
UE522 01006	1	6	60	6
UE522 01007	1	7	60	6
UE522 01008	1	8	60	6
UE522 01010	1	10	60	6
UE522 01012	1	12	60	6
UE522 01204	1.2	4	60	6
UE522 01206	1.2	6	60	6
UE522 01208	1.2	8	60	6
UE522 01210	1.2	10	60	6
UE522 01212	1.2	12	60	6
UE522 01506	1.5	6	60	6
UE522 01508	1.5	8	60	6
UE522 01510	1.5	10	60	6
UE522 01512	1.5	12	60	6
UE522 01514	1.5	14	60	6
UE522 01516	1.5	16	60	6
UE522 02008	2	8	60	6

품목코드	DC	APMX	OAL	DCONMS
	날경	날장	전장	자루경
UE522 02010	2	10	60	6
UE522 02012	2	12	60	6
UE522 02014	2	14	60	6
UE522 02016	2	16	60	6
UE522 02510	2.5	10	60	6
UE522 02512	2.5	12	60	6
UE522 02516	2.5	16	60	6
UE522 02520	2.5	20	60	6
UE522 02526	2.5	26	60	6
UE522 03010	3	10	70	6
UE522 03012	3	12	70	6
UE522 03014	3	14	70	6
UE522 03016	3	16	70	6
UE522 03016S3	3	16	100	3
UE522 03020	3	20	70	6
UE522 03026	3	26	70	6
UE522 03030	3	30	70	6
UE522 04012	4	12	70	6
UE522 04016	4	16	70	6
UE522 04020	4	20	70	6

▶ 적용 피삭재

○ : 적합 ◎ : 매우 적합

H		P			K	N			M	S
열처리강		탄소강	합금강	프리하든강	주철	동	흑연	알루미늄	스테인리스	내열합금
SKD61 ~HRc55	SKD11 HRc55~	~HB225	HB225 ~325	HRc30~50	~FCD500					
○		○	◎	◎	○					

UE522 2날 스퀘어 엔드밀

Endmill

	품목코드	DC	APMX	OAL	DCONMS	품목코드	DC	APMX	OAL	DCONMS
		날경	날장	전장	자루경		날경	날장	전장	자루경
Zamus Star	UE522 04020S4	4	20	100	4	UE522 09045	9	45	100	10
	UE522 04026	4	26	70	6	UE522 10025	10	25	100	10
	UE522 04030	4	30	70	6	UE522 10030100	10	30	100	10
	UE522 05015	5	15	70	6	UE522 10030	10	30	80	10
	UE522 05020	5	20	70	6	UE522 10035	10	35	90	10
E-Star	UE522 05025100	5	25	100	6	UE522 10040120	10	40	120	10
	UE522 05025	5	25	70	6	UE522 10040	10	40	90	10
	UE522 05030	5	30	80	6	UE522 10045	10	45	100	10
U-Wing	UE522 05035	5	35	90	6	UE522 10050200	10	50	200	10
	UE522 05040	5	40	100	6	UE522 10050150	10	50	150	10
	UE522 06015080	6	15	80	6	UE522 10050	10	50	100	10
Zamus Thunder	UE522 06015	6	15	60	6	UE522 10055	10	55	150	10
	UE522 06020090	6	20	90	6	UE522 10060200	10	60	200	10
	UE522 06020	6	20	70	6	UE522 10060155	10	60	155	10
	UE522 06025	6	25	75	6	UE522 10060	10	60	110	10
X-Star	UE522 06030150	6	30	150	6	UE522 11050	11	50	110	12
	UE522 06030100	6	30	100	6	UE522 12035	12	35	90	12
	UE522 06030	6	30	80	6	UE522 12040120	12	40	120	12
	UE522 06035	6	35	90	6	UE522 12040	12	40	100	12
S-Wing	UE522 06040120	6	40	120	6	UE522 12045	12	45	130	12
	UE522 06040	6	40	90	6	UE522 12050150	12	50	150	12
	UE522 06045	6	45	150	6	UE522 12050	12	50	100	12
A-Wing	UE522 07035	7	35	85	8	UE522 12055	12	55	110	12
	UE522 08020	8	20	100	8	UE522 12060200	12	60	200	12
	UE522 08025	8	25	80	8	UE522 12060150	12	60	150	12
	UE522 08030100	8	30	100	8	UE522 12060	12	60	110	12
Standard	UE522 08030	8	30	80	8	UE522 12065	12	65	150	12
	UE522 08035	8	35	90	8	UE522 12070200	12	70	200	12
	UE522 08040150	8	40	150	8	UE522 12070	12	70	120	12
	UE522 08040120	8	40	120	8	UE522 14040	14	40	110	16
Copper-Mate	UE522 08040	8	40	90	8	UE522 14050	14	50	110	16
	UE522 08045	8	45	100	8	UE522 14060150	14	60	150	16
	UE522 08050150	8	50	150	8	UE522 14060	14	60	120	16
Gra-Mate	UE522 08050	8	50	100	8	UE522 16040150	16	40	150	16

▶ 적용 피삭재

○ : 적합 ◎ : 매우 적합

H		P			K	N			M	S
열처리강		탄소강	합금강	프리하든강	주철	동	흑연	알루미늄	스테인리스	내열합금
SKD61 ~HRc55	SKD11 HRc55~	~HB225	HB225 ~325	HRc30~50	~FCD500					
○		○	◎	◎	○					

UE522 2날 스퀘어 엔드밀

Endmill

품목코드	DC	APMX	OAL	DCONMS	품목코드	DC	APMX	OAL	DCONMS
	날경	날장	전장	자루경		날경	날장	전장	자루경
UE522 16040	16	40	120	16	UE522 20050150	20	50	150	20
UE522 16050150	16	50	150	16	UE522 20050	20	50	110	20
UE522 16050	16	50	110	16	UE522 20060	20	60	130	20
UE522 16060	16	60	120	16	UE522 20070	20	70	130	20
UE522 16070200	16	70	200	16	UE522 20080	20	80	150	20
UE522 16070150	16	70	150	16	UE522 20090200	20	90	200	20
UE522 16070	16	70	130	16	UE522 20090	20	90	150	20
UE522 16080	16	80	150	16	UE522 200110	20	110	200	20
UE522 16090	16	90	150	16	UE522 200120	20	120	250	20
UE522 160110	16	110	200	16	UE522 22075	22	75	150	20
UE522 160120	16	120	250	16	UE522 220110	22	110	200	20
UE522 18050	18	50	120	20	UE522 25070	25	70	150	25
UE522 18060	18	60	120	18	UE522 25090	25	90	150	25
UE522 18070	18	70	130	20	UE522 250110	25	110	200	25
UE522 180100	18	100	200	20	UE522 250120	25	120	250	25

- Zamus Star
- E-Star
- U-Wing
- Zamus Thunder
- X-Star
- S-Wing
- A-Wing
- Standard
- Copper-Mate
- Gra-Mate

▶ 적용 피삭재

○ : 적합 ◎ : 매우 적합

H		P			K	N			M	S
열처리강		탄소강	합금강	프리하든강	주철	동	흑연	알루미늄	스테인리스	내열합금
SKD61 ~HRC55	SKD11 HRC55~	~HB225	HB225 ~325	HRC30~50	~FCD500					
○		○	◎	◎	○					

UE524 4날 스퀘어 엔드밀

Endmill

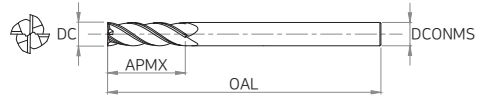
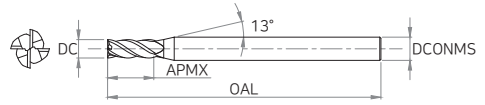

▶ 제품허용공차

날경(DC)		자루경
Ø1 ~ Ø25	0 ~ -0.03	h5

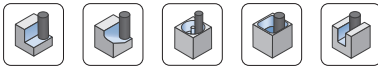

품목코드	DC	APMX	OAL	DCONMS	품목코드	DC	APMX	OAL	DCONMS
	날경	날장	전장	자루경		날경	날장	전장	자루경
UE524 01003	1	3	60	6	UE524 01526	1.5	26	60	6
UE524 01004	1	4	60	6	UE524 02008	2	8	60	6
UE524 01005	1	5	60	6	UE524 02008S4	2	8	40	4
UE524 01006	1	6	60	6	UE524 02010	2	10	60	6
UE524 01007	1	7	60	6	UE524 02012	2	12	60	6
UE524 01008	1	8	60	6	UE524 02014	2	14	60	6
UE524 01010	1	10	60	6	UE524 02016	2	16	60	6
UE524 01012	1	12	60	6	UE524 02510	2.5	10	60	6
UE524 01204	1.2	4	60	6	UE524 02512	2.5	12	60	6
UE524 01206	1.2	6	60	6	UE524 02516	2.5	16	60	6
UE524 01208	1.2	8	60	6	UE524 02520	2.5	20	60	6
UE524 01210	1.2	10	60	6	UE524 02526	2.5	26	60	6
UE524 01212	1.2	12	60	6	UE524 03010	3	10	70	6
UE524 01506	1.5	6	60	6	UE524 03012	3	12	70	6
UE524 01508	1.5	8	60	6	UE524 03014	3	14	70	6
UE524 01510	1.5	10	60	6	UE524 03016	3	16	70	6
UE524 01512	1.5	12	60	6	UE524 03016S3	3	16	100	3
UE524 01514	1.5	14	60	6	UE524 03020	3	20	70	6
UE524 01516	1.5	16	60	6	UE524 03026	3	26	70	6
UE524 01520	1.5	20	60	6	UE524 03030	3	30	70	6

▶ 적용 피삭재

○ : 적합 ◎ : 매우 적합

H		P			K	N			M	S
열처리강		탄소강	합금강	프리하든강	주철	동	흑연	알루미늄	스테인리스	내열합금
SKD61 ~HRc55	SKD11 HRc55~	~HB225	HB225 ~325	HRC30~50	~FCD500					
○		○	◎	◎	○					

UE524 4날 스쿼어 엔드밀

Endmill

품목코드	DC	APMX	OAL	DCONMS	품목코드	DC	APMX	OAL	DCONMS
	날경	날장	전장	자루경		날경	날장	전장	자루경
UE524 03035	3	35	90	6	UE524 08040	8	40	90	8
UE524 04012	4	12	70	6	UE524 08045	8	45	100	8
UE524 04016	4	16	70	6	UE524 08050150	8	50	150	8
UE524 04020	4	20	70	6	UE524 08050	8	50	100	8
UE524 04020S4	4	20	100	4	UE524 08060	8	60	155	8
UE524 04026	4	26	70	6	UE524 08080	8	80	200	8
UE524 04030	4	30	70	6	UE524 09045	9	45	100	10
UE524 05015	5	15	70	6	UE524 10025	10	25	100	10
UE524 05020	5	20	70	6	UE524 100100	10	30	100	10
UE524 05025100	5	25	100	6	UE524 10030	10	30	80	10
UE524 05025	5	25	70	6	UE524 10035	10	35	90	10
UE524 05030	5	30	80	6	UE524 10040120	10	40	120	10
UE524 05035	5	35	90	6	UE524 10040	10	40	90	10
UE524 05040	5	40	100	6	UE524 10045	10	45	100	10
UE524 06015080	6	15	80	6	UE524 10050200	10	50	200	10
UE524 06015	6	15	60	6	UE524 10050150	10	50	150	10
UE524 06020090	6	20	90	6	UE524 10050	10	50	100	10
UE524 06020	6	20	70	6	UE524 10055	10	55	150	10
UE524 06025	6	25	75	6	UE524 10060200	10	60	200	10
UE524 06030150	6	30	150	6	UE524 10060155	10	60	155	10
UE524 06030100	6	30	100	6	UE524 10060	10	60	110	10
UE524 06030	6	30	80	6	UE524 10080200	10	80	200	10
UE524 06035	6	35	90	6	UE524 11050	11	50	110	12
UE524 06040120	6	40	120	6	UE524 12030	12	30	110	12
UE524 06040	6	40	90	6	UE524 12035	12	35	90	12
UE524 06045	6	45	150	6	UE524 12040120	12	40	120	12
UE524 07035	7	35	85	8	UE524 12040	12	40	100	12
UE524 08020	8	20	100	8	UE524 12045	12	45	130	12
UE524 08025	8	25	80	8	UE524 12050150	12	50	150	12
UE524 08030100	8	30	100	8	UE524 12050	12	50	100	12
UE524 08030	8	30	80	8	UE524 12055	12	55	110	12
UE524 08035	8	35	90	8	UE524 12060200	12	60	200	12
UE524 08040150	8	40	150	8	UE524 12060150	12	60	150	12
UE524 08040120	8	40	120	8	UE524 12060	12	60	110	12

Zamus Star
E-Star
U-Wing
Zamus Thunder
X-Star
S-Wing
A-Wing
Standard
Copper-Mate
Gra-Mate

▶ 적용 피삭재

○ : 적합 ◎ : 매우 적합

H		P			K	N			M	S
열처리강		탄소강	합금강	프리하트강	주철	동	흑연	알루미늄	스테인리스	내열합금
SKD61 ~HRc55	SKD11 HRc55~	~HB225	HB225 ~325	HRc30~50	~FCD500					
○		○	◎	◎	○					

UE524 4날 스퀘어 엔드밀

Endmill

품목코드	DC	APMX	OAL	DCONMS	품목코드	DC	APMX	OAL	DCONMS
	날경	날장	전장	자루경		날경	날장	전장	자루경
UE524 12065	12	65	150	12	UE524 180100	18	100	200	20
UE524 12070200	12	70	200	12	UE524 20050150	20	50	150	20
UE524 12070	12	70	120	12	UE524 20050	20	50	110	20
UE524 12080	12	80	200	12	UE524 20060	20	60	130	20
UE524 14040	14	40	110	16	UE524 20070	20	70	130	20
UE524 14050	14	50	110	16	UE524 20080	20	80	150	20
UE524 14060	14	60	150	16	UE524 20090200	20	90	200	20
UE524 16040	16	40	150	16	UE524 20090	20	90	150	20
UE524 16050150	16	50	150	16	UE524 200100	20	100	200	20
UE524 16050	16	50	110	16	UE524 200110	20	110	200	20
UE524 16060	16	60	120	16	UE524 200120	20	120	250	20
UE524 16070200	16	70	200	16	UE524 200130	20	130	250	20
UE524 16070150	16	70	150	16	UE524 22075	22	75	150	20
UE524 16070	16	70	130	16	UE524 220110	22	110	200	20
UE524 16080	16	80	150	16	UE524 25070	25	70	150	25
UE524 16090	16	90	150	16	UE524 25090	25	90	150	25
UE524 160100	16	100	200	16	UE524 250100	25	100	200	25
UE524 160110	16	110	200	16	UE524 250110	25	110	200	25
UE524 160120	16	120	250	16	UE524 250120	25	120	250	25
UE524 18050	18	50	120	20	UE524 250150	25	150	250	25
UE524 18070	18	70	130	20					

Zamus Star

E-Star

U-Wing

Zamus Thunder

X-Star

S-Wing

A-Wing

Standard

Copper -Mate

Gra -Mate

▶ 적용 피삭재 ○ : 적합 ◎ : 매우 적합

H		P			K	N			M	S
열처리강		탄소강	합금강	프리하든강	주철	동	흑연	알루미늄	스테인리스	내열합금
SKD61 ~HRc55	SKD11 HRc55~	~HB225	HB225 ~325	HRc30~50	~FCD500					
○		○	◎	◎	○					

ULE504 4날 자동선반용 스퀘어 엔드밀

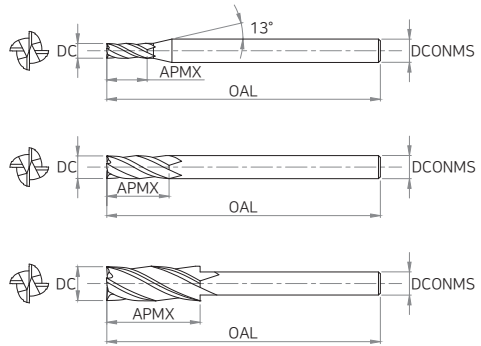

▶ 제품허용공차

날경(DC)		자루경
Ø3 ~ Ø16	0 ~ -0.02	h5

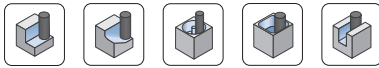

품목코드	DC	APMX	OAL	DCONMS
	날경	날장	전장	자루경
ULE504 030S04	3	3	35	4
ULE504 040S04	4	4	35	4
ULE504 060S06	6	6	35	6
ULE504 070S07	7	20	45	7
ULE504 080S08	8	8	45	8
ULE504 080S06	8	8	35	6
ULE504 080S07	8	15	45	7
ULE504 090S07	9	15	45	7
ULE504 100S06	10	10	35	6
ULE504 100S10	10	15	45	10
ULE504 100S07	10	15	45	7
ULE504 110S07	11	15	45	7
ULE504 120S10	12	12	45	10
ULE504 120S06	12	12	35	6
ULE504 120S07	12	15	45	7
ULE504 120-25S10	12	25	55	10
ULE504 130S10	13	25	55	10
ULE504 140S10	14	25	55	10
ULE504 140S07	14	25	55	7
ULE504 160S10	16	25	60	10

▶ 적용 피삭재

○ : 적합 ◎ : 매우 적합

H		P			K	N			M	S
열처리강		탄소강	합금강	프리하든강	주철	동	흑연	알루미늄	스테인리스	내열합금
SKD61 ~HRc55	SKD11 HRc55~	~HB225	HB225 ~325	HRc30~50	~FCD500					
○		○	◎	◎	○					

UXE502 2날 강력절삭용 스퀘어 엔드밀

Endmill

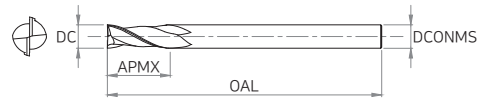
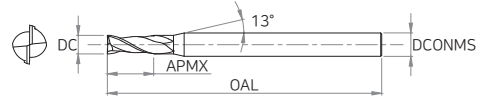

▶ 제품허용공차

날경(DC)		자루경
Ø0.1 ~ Ø7	0 ~ -0.012	h5
Ø8 ~ Ø20	0 ~ -0.015	

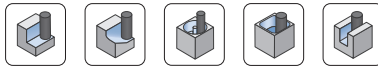

품목코드	DC	APMX	OAL	DCONMS	품목코드	DC	APMX	OAL	DCONMS
	날경	날장	전장	자루경		날경	날장	전장	자루경
UXE502 001001	0.1	0.1	40	4	UXE502 007021	0.7	2.1	40	4
UXE502 001	0.1	0.2	40	4	UXE502 008008	0.8	0.8	40	4
UXE502 001003	0.1	0.3	40	4	UXE502 0008	0.8	1.6	40	4
UXE502 002002	0.2	0.2	40	4	UXE502 008024	0.8	2.4	40	4
UXE502 002	0.2	0.4	40	4	UXE502 009009	0.9	0.9	40	4
UXE502 002006	0.2	0.6	40	4	UXE502 009	0.9	1.8	40	4
UXE502 003003	0.3	0.3	40	4	UXE502 009027	0.9	2.7	40	4
UXE502 003	0.3	0.6	40	4	UXE502 01001	1	1	40	6
UXE502 003009	0.3	0.9	40	4	UXE502 01002	1	2	40	6
UXE502 004004	0.4	0.4	40	4	UXE502 010	1	2.5	50	6
UXE502 004	0.4	0.8	40	4	UXE502 01003	1	3	50	6
UXE502 004012	0.4	1.2	40	4	UXE502 01004	1	4	50	6
UXE502 005005	0.5	0.5	40	4	UXE502 01006	1	6	50	6
UXE502 005	0.5	1	40	4	UXE502 01202	1.2	2	40	6
UXE502 005015	0.5	1.5	40	4	UXE502 012	1.2	3	50	6
UXE502 006006	0.6	0.6	40	4	UXE502 01204	1.2	4	50	6
UXE502 006	0.6	1.2	40	4	UXE502 01206	1.2	6	50	6
UXE502 006018	0.6	1.8	40	4	UXE502 015015	1.5	1.5	40	6
UXE502 007007	0.7	0.7	40	4	UXE502 01503	1.5	3	40	6
UXE502 007	0.7	1.4	40	4	UXE502 015	1.5	4	50	6

▶ 적용 피삭재

○ : 적합 ◎ : 매우 적합

H		P			K	N			M	S
열처리강		탄소강	합금강	프리하든강	주철	동	흑연	알루미늄	스테인리스	내열합금
SKD61 ~HRc55	SKD11 HRc55~	~HB225	HB225 ~325	HRc30~50	~FCD500					
○		○	◎	◎	○					

UXE502

2날 강력절삭용 스퀘어 엔드밀

Endmill

품목코드	DC	APMX	OAL	DCONMS	품목코드	DC	APMX	OAL	DCONMS
	날경	날장	전장	자루경		날경	날장	전장	자루경
UXE502 01506	1.5	6	50	6	UXE502 05010	5	10	50	6
UXE502 01508	1.5	8	50	6	UXE502 050	5	15	60	6
UXE502 01510	1.5	10	50	6	UXE502 05020	5	20	60	6
UXE502 02002	2	2	40	6	UXE502 05025	5	25	60	6
UXE502 02004	2	4	40	6	UXE502 05513	5.5	13	50	6
UXE502 020	2	6	50	6	UXE502 06006	6	6	50	6
UXE502 02008	2	8	50	6	UXE502 06012	6	12	50	6
UXE502 02010	2	10	50	6	UXE502 060	6	15	60	6
UXE502 02012	2	12	50	6	UXE502 06020	6	20	60	6
UXE502 025025	2.5	2.5	40	6	UXE502 06025	6	25	60	6
UXE502 02505	2.5	5	40	6	UXE502 06513	6.5	13	60	8
UXE502 025	2.5	7	50	6	UXE502 07018	7	18	60	8
UXE502 02510	2.5	10	50	6	UXE502 08016	8	16	60	8
UXE502 02512	2.5	12	50	6	UXE502 080	8	20	70	8
UXE502 03003	3	3	40	6	UXE502 08025	8	25	70	8
UXE502 03006	3	6	40	6	UXE502 08030	8	30	70	8
UXE502 030	3	8	50	6	UXE502 10022	10	22	65	10
UXE502 03010	3	10	50	6	UXE502 100	10	25	75	10
UXE502 03012	3	12	50	6	UXE502 10030	10	30	75	10
UXE502 03014	3	14	50	6	UXE502 10035	10	35	75	10
UXE502 03510	3.5	10	50	6	UXE502 12026	12	26	70	12
UXE502 04004	4	4	40	6	UXE502 120	12	30	80	12
UXE502 04008	4	8	40	6	UXE502 12035	12	35	80	12
UXE502 040	4	10	50	6	UXE502 12040	12	40	80	12
UXE502 04012	4	12	50	6	UXE502 140	14	35	100	16
UXE502 04014	4	14	50	6	UXE502 160	16	32	100	16
UXE502 04016	4	16	50	6	UXE502 16040	16	40	100	16
UXE502 04511	4.5	11	50	6	UXE502 180	18	45	100	20
UXE502 05005	5	5	50	6	UXE502 200	20	45	100	20

Zamus Star

E-Star

U-Wing

Zamus Thunder

X-Star

S-Wing

A-Wing

Standard

Copper-Mate

Gra-Mate

▶ 적용 피삭재

○ : 적합 ◎ : 매우 적합

H		P			K	N			M	S
열처리강		탄소강	합금강	프리하트강	주철	동	흑연	알루미늄	스테인리스	내열합금
SKD61 ~HRC55	SKD11 HRC55~	~HB225	HB225 ~325	HRC30~50	~FCD500					
○		○	◎	◎	○					

UXE504 4날 강력절삭용 스퀘어 엔드밀

Endmill

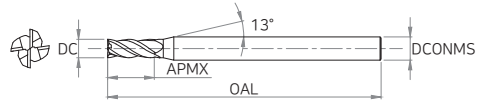

▶ 제품허용공차

날경(DC)		자루경
Ø1 ~ Ø25	0 ~ -0.03	h5

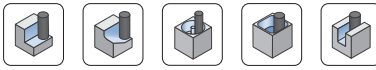

품목코드	DC	APMX	OAL	DCONMS	품목코드	DC	APMX	OAL	DCONMS
	날경	날장	전장	자루경		날경	날장	전장	자루경
UXE504 01001	1	1	40	6	UXE504 02010	2	10	50	6
UXE504 01002	1	2	40	6	UXE504 02012	2	12	50	6
UXE504 010	1	2.5	50	6	UXE504 025025	2.5	2.5	40	6
UXE504 01003	1	3	50	6	UXE504 02505	2.5	5	40	6
UXE504 01004	1	4	50	6	UXE504 025	2.5	7	50	6
UXE504 01006	1	6	50	6	UXE504 02510	2.5	10	50	6
UXE504 01202	1.2	2	40	6	UXE504 02512	2.5	12	50	6
UXE504 012	1.2	3	50	6	UXE504 03003	3	3	40	6
UXE504 01204	1.2	4	50	6	UXE504 03006	3	6	40	6
UXE504 01206	1.2	6	50	6	UXE504 030	3	8	50	6
UXE504 015015	1.5	1.5	40	6	UXE504 03010	3	10	50	6
UXE504 01503	1.5	3	40	6	UXE504 03012	3	12	50	6
UXE504 015	1.5	4	50	6	UXE504 03014	3	14	50	6
UXE504 01506	1.5	6	50	6	UXE504 04004	4	4	40	6
UXE504 01508	1.5	8	50	6	UXE504 04008	4	8	40	6
UXE504 01510	1.5	10	50	6	UXE504 040	4	10	50	6
UXE504 02002	2	2	40	6	UXE504 04012	4	12	50	6
UXE504 02004	2	4	40	6	UXE504 04014	4	14	50	6
UXE504 020	2	6	50	6	UXE504 04016	4	16	50	6
UXE504 02008	2	8	50	6	UXE504 05005	5	5	50	6

▶ 적용 피삭재

○ : 적함 ◎ : 매우 적함

H		P			K	N			M	S
열처리강		탄소강	합금강	프리하든강	주철	동	흑연	알루미늄	스테인리스	내열합금
SKD61 ~HRc55	SKD11 HRc55~	~HB225	HB225 ~325	Hrc30~50	~FCD500					
○		○	◎	◎	○					

UXE504

4날 강력절삭용 스퀘어 엔드밀

Endmill

품목코드	DC	APMX	OAL	DCONMS	품목코드	DC	APMX	OAL	DCONMS
	날경	날장	전장	자루경		날경	날장	전장	자루경
UXE504 05010	5	10	50	6	UXE504 10022	10	22	65	10
UXE504 050	5	15	60	6	UXE504 100	10	25	75	10
UXE504 05020	5	20	60	6	UXE504 10030	10	30	75	10
UXE504 05025	5	25	60	6	UXE504 10035	10	35	75	10
UXE504 06006	6	6	50	6	UXE504 12026	12	26	70	12
UXE504 06012	6	12	50	6	UXE504 120	12	30	80	12
UXE504 060	6	15	60	6	UXE504 12035	12	35	80	12
UXE504 06020	6	20	60	6	UXE504 12040	12	40	80	12
UXE504 06025	6	25	60	6	UXE504 140	14	35	100	16
UXE504 08016	8	16	60	8	UXE504 16032	16	32	100	16
UXE504 080	8	20	70	8	UXE504 160	16	40	100	16
UXE504 08025	8	25	70	8	UXE504 180	18	45	100	20
UXE504 08030	8	30	70	8	UXE504 200	20	45	100	20

- Zamus Star
- E-Star
- U-Wing
- Zamus Thunder
- X-Star
- S-Wing
- A-Wing
- Standard
- Copper-Mate
- Gra-Mate

▶ 적용 피삭재

○ : 적합 ◎ : 매우 적합

H		P			K	N			M	S
열처리강		탄소강	합금강	프리하든강	주철	동	흑연	알루미늄	스테인리스	내열합금
SKD61 ~HRc55	SKD11 HRc55~	~HB225	HB225 ~325	HRc30~50	~FCD500					
○		○	◎	◎	○					

UTE502 2날 테이퍼 스퀘어 엔드밀

Endmill

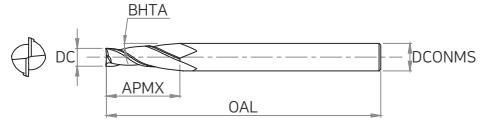
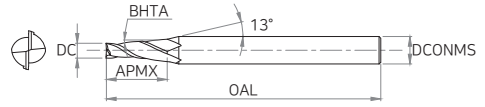

▶ 제품허용공차

날경(DC)		자루경
∅0.3 ~ ∅10	0 ~ -0.03	h5

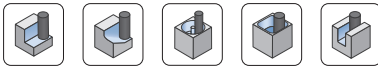

품목코드	DC	BHTA	APMX	OAL	DCONMS	품목코드	DC	BHTA	APMX	OAL	DCONMS
	날경	테이퍼각	날장	전장	자루경		날경	테이퍼각	날장	전장	자루경
UTE502 003005	0.3	0.5	1.2	40	4	UTE502 00503	0.5	3	2	45	4
UTE502 0030	0.3	1	1.2	40	4	UTE502 00505	0.5	5	2.5	45	4
UTE502 003015	0.3	1.5	1.2	40	4	UTE502 00507	0.5	7	2.5	45	4
UTE502 00302	0.3	2	1.2	40	4	UTE502 00510	0.5	10	2.5	45	4
UTE502 00303	0.3	3	1.5	40	4	UTE502 006005	0.6	0.5	2.4	45	4
UTE502 00305	0.3	5	1.5	40	4	UTE502 00601	0.6	1	2.4	45	4
UTE502 00307	0.3	7	1.5	40	4	UTE502 006015	0.6	1.5	2.4	45	4
UTE502 00310	0.3	10	1.5	40	4	UTE502 00602	0.6	2	2.4	45	4
UTE502 004005	0.4	0.5	1.6	40	4	UTE502 00603	0.6	3	2.4	45	4
UTE502 00401	0.4	1	1.6	40	4	UTE502 00605	0.6	5	3	45	4
UTE502 004015	0.4	1.5	1.6	40	4	UTE502 00607	0.6	7	3	45	4
UTE502 00402	0.4	2	1.6	40	4	UTE502 00610	0.6	10	3	45	4
UTE502 00403	0.4	3	1.6	40	4	UTE502 007005	0.7	0.5	2.8	45	4
UTE502 00405	0.4	5	2	40	4	UTE502 00701	0.7	1	2.8	45	4
UTE502 00407	0.4	7	2	40	4	UTE502 007015	0.7	1.5	2.8	45	4
UTE502 00410	0.4	10	2	40	4	UTE502 00702	0.7	2	2.8	45	4
UTE502 005005	0.5	0.5	2	45	4	UTE502 00703	0.7	3	2.8	45	4
UTE502 00501	0.5	1	2	45	4	UTE502 00705	0.7	5	3.5	45	4
UTE502 005015	0.5	1.5	2	45	4	UTE502 00707	0.7	7	3.5	45	4
UTE502 00502	0.5	2	2	45	4	UTE502 00710	0.7	10	3.5	45	4

▶ 적용 피삭재

○ : 적합 ◎ : 매우 적합

H		P			K	N			M	S
열처리강		탄소강	합금강	프리하든강	주철	동	흑연	알루미늄	스테인리스	내열합금
SKD61 ~HRc55	SKD11 HRc55~	~HB225	HB225 ~325	HRc30~50	~FCD500					
○		○	◎	◎	○					

UTE502 2날 테이퍼 스퀘어 엔드밀

Endmill

품목코드	DC	BHTA	APMX	OAL	DCONMS	품목코드	DC	BHTA	APMX	OAL	DCONMS
	날경	테이퍼각	날장	전장	자루경		날경	테이퍼각	날장	전장	자루경
UTE502 008005	0.8	0.5	3.2	45	4	UTE502 025015	2.5	1.5	10	50	6
UTE502 00801	0.8	1	3.2	45	4	UTE502 02502	2.5	2	12	50	6
UTE502 008015	0.8	1.5	3.2	45	4	UTE502 02503	2.5	3	12	50	6
UTE502 00802	0.8	2	3.2	45	4	UTE502 02505	2.5	5	14	50	6
UTE502 00803	0.8	3	3.2	45	4	UTE502 02507	2.5	7	14	50	6
UTE502 00805	0.8	5	4	45	4	UTE502 02510	2.5	10	14	50	8
UTE502 00807	0.8	7	4	45	4	UTE502 030005	3	0.5	12	50	6
UTE502 00810	0.8	10	4	45	4	UTE502 03001	3	1	12	50	6
UTE502 010005	1	0.5	4	50	4	UTE502 030015	3	1.5	12	50	6
UTE502 01001	1	1	4	50	4	UTE502 03002	3	2	14	50	6
UTE502 010015	1	1.5	4	50	4	UTE502 03003	3	3	14	50	6
UTE502 01002	1	2	6	50	4	UTE502 03005	3	5	16	50	6
UTE502 01003	1	3	6	50	4	UTE502 03007	3	7	16	50	8
UTE502 01005	1	5	8	50	4	UTE502 03010	3	10	16	50	10
UTE502 01007	1	7	8	50	4	UTE502 040005	4	0.5	16	60	6
UTE502 01010	1	10	8	50	4	UTE502 04001	4	1	16	60	6
UTE502 015005	1.5	0.5	6	50	4	UTE502 040015	4	1.5	16	60	6
UTE502 01501	1.5	1	6	50	4	UTE502 04002	4	2	16	60	6
UTE502 015015	1.5	1.5	6	50	4	UTE502 04003	4	3	19	60	6
UTE502 01502	1.5	2	8	50	4	UTE502 04005	4	5	22	65	8
UTE502 01503	1.5	3	8	50	4	UTE502 04007	4	7	16	65	8
UTE502 01505	1.5	5	10	50	4	UTE502 04010	4	10	17	65	10
UTE502 01507	1.5	7	10	50	4	UTE502 060005	6	0.5	20	65	8
UTE502 01510	1.5	10	10	50	6	UTE502 06001	6	1	20	65	8
UTE502 020005	2	0.5	8	50	4	UTE502 060015	6	1.5	20	65	8
UTE502 020015	2	1.5	8	50	4	UTE502 06002	6	2	20	65	8
UTE502 02001	2	1	8	50	4	UTE502 06003	6	3	19	65	8
UTE502 02002	2	2	10	50	4	UTE502 06005	6	5	22	75	10
UTE502 02003	2	3	10	50	4	UTE502 06007	6	7	24	75	12
UTE502 02005	2	5	12	50	6	UTE502 06010	6	10	17	75	12
UTE502 02007	2	7	12	50	6	UTE502 070005	7	0.5	28	70	8
UTE502 02010	2	10	12	50	8	UTE502 07001	7	1	28	70	8
UTE502 025005	2.5	0.5	10	50	6	UTE502 070015	7	1.5	28	70	10
UTE502 02501	2.5	1	10	50	6	UTE502 07002	7	2	28	80	10

Zamus Star

E-Star

U-Wing

Zamus Thunder

X-Star

S-Wing

A-Wing

Standard

Copper-Mate

Gra-Mate

▶ 적용 피삭재

○ : 적합 ◎ : 매우 적합

H		P			K	N			M	S
열처리강		탄소강	합금강	프리하든강	주철	동	흑연	알루미늄	스테인리스	내열합금
SKD61 ~HRc55	SKD11 HRc55~	~HB225	HB225 ~325	HRc30~50	~FCD500					
○		○	◎	◎	○					

UTE502 2날 테이퍼 스퀘어 엔드밀

Endmill

품목코드	DC	BHTA	APMX	OAL	DCONMS	품목코드	DC	BHTA	APMX	OAL	DCONMS
	날경	테이퍼각	날장	전장	자루경		날경	테이퍼각	날장	전장	자루경
UTE502 07003	7	3	28	80	10	UTE502 08010S25	8	10	48	150	25
UTE502 07005	7	5	28	80	12	UTE502 100005	10	0.5	40	90	12
UTE502 080005	8	0.5	35	90	10	UTE502 10001	10	1	40	90	12
UTE502 08001	8	1	35	90	10	UTE502 100015	10	1.5	38	90	12
UTE502 080015	8	1.5	35	90	10	UTE502 10002	10	2	40	75	16
UTE502 08002	8	2	28	90	10	UTE502 10003	10	3	40	100	16
UTE502 08003	8	3	38	90	12	UTE502 10005	10	5	34	100	16
UTE502 08005	8	5	45	100	16	UTE502 10007	10	7	40	90	20
UTE502 08007	8	7	32	90	16	UTE502 10010	10	10	42	100	25
UTE502 08010	8	10	34	100	20						

Zamus Star

E-Star

U-Wing

Zamus Thunder

X-Star

S-Wing

A-Wing

Standard

Copper -Mate

Gra -Mate

▶ 적용 피삭재

○ : 적합 ◎ : 매우 적합

H		P			K	N			M	S
열처리강		탄소강	합금강	프리하든강	주철	동	흑연	알루미늄	스테인리스	내열합금
SKD61 ~HRc55	SKD11 HRc55~	~HB225	HB225 ~325	HRc30~50	~FCD500					
○		○	◎	◎	○					

UTE504 4날 테이퍼 스퀘어 엔드밀

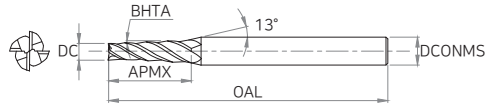

Endmill

▶ 제품허용공차

날경(DC)		자루경
φ0.8 ~ φ10	0 ~ -0.03	h5

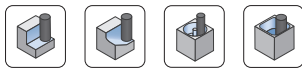

CARBIDE AICrN 30° HELIX 절삭조건 P.690

품목코드	DC	BHTA	APMX	OAL	DCONMS	품목코드	DC	BHTA	APMX	OAL	DCONMS
	날경	테이퍼각	날장	전장	자루경		날경	테이퍼각	날장	전장	자루경
UTE504 00800504	0.8	0.5	4	45	4	UTE504 01000504	1	0.5	4	50	4
UTE504 00801004	0.8	1	4	45	4	UTE504 01001004	1	1	4	50	4
UTE504 00801504	0.8	1.5	4	45	4	UTE504 01001504	1	1.5	4	50	4
UTE504 00802004	0.8	2	4	45	4	UTE504 01002004	1	2	4	50	4
UTE504 00800506	0.8	0.5	6	45	4	UTE504 01003004	1	3	4	50	4
UTE504 00801006	0.8	1	6	45	4	UTE504 01000506	1	0.5	6	50	4
UTE504 00801506	0.8	1.5	6	45	4	UTE504 01001006	1	1	6	50	4
UTE504 00802006	0.8	2	6	45	4	UTE504 01001506	1	1.5	6	50	4
UTE504 00800508	0.8	0.5	8	45	4	UTE504 01002006	1	2	6	50	4
UTE504 00801008	0.8	1	8	45	4	UTE504 01003006	1	3	6	50	4
UTE504 00801508	0.8	1.5	8	45	4	UTE504 01000508	1	0.5	8	50	4
UTE504 00802008	0.8	2	8	45	4	UTE504 01001008	1	1	8	50	4
UTE504 00800510	0.8	0.5	10	45	4	UTE504 01001508	1	1.5	8	50	4
UTE504 00801010	0.8	1	10	45	4	UTE504 01002008	1	2	8	50	4
UTE504 00801510	0.8	1.5	10	45	4	UTE504 01003008	1	3	8	50	4
UTE504 00802010	0.8	2	10	45	4	UTE504 01000510	1	0.5	10	50	4
UTE504 00800512	0.8	0.5	12	45	4	UTE504 01001010	1	1	10	50	4
UTE504 00801012	0.8	1	12	45	4	UTE504 01001510	1	1.5	10	50	4
UTE504 00801512	0.8	1.5	12	45	4	UTE504 01002010	1	2	10	50	4
UTE504 00802012	0.8	2	12	45	4	UTE504 01003010	1	3	10	50	4

Zamus Star

E-Star

U-Wing

Zamus Thunder

X-Star

S-Wing

A-Wing

Standard

Copper-Mate

Gra-Mate

▶ 적용 피삭재

○ : 적합 ◎ : 매우 적합

H		P			K	N			M	S
열처리강		탄소강	합금강	프리하든강	주철	동	흑연	알루미늄	스테인리스	내열합금
SKD61 ~HRc55	SKD11 HRc55~	~HB225	HB225 ~325	HRc30~50	~FCD500					
○		○	◎	◎	○					

UTE504 4날 테이퍼 스퀘어 엔드밀

Endmill

종류	품목코드	DC	BHTA	APMX	OAL	DCONMS	품목코드	DC	BHTA	APMX	OAL	DCONMS
		날경	테이퍼각	날장	전장	자루경		날경	테이퍼각	날장	전장	자루경
Zamus Star	UTE504 01000512	1	0.5	12	50	4	UTE504 01203016	1.2	3	16	50	4
	UTE504 01001012	1	1	12	50	4	UTE504 01500506	1.5	0.5	6	50	4
	UTE504 01001512	1	1.5	12	50	4	UTE504 01501006	1.5	1	6	50	4
	UTE504 01002012	1	2	12	50	4	UTE504 01501506	1.5	1.5	6	50	4
	UTE504 01003012	1	3	12	50	4	UTE504 01502006	1.5	2	6	50	4
E-Star	UTE504 01000516	1	0.5	16	50	4	UTE504 01503006	1.5	3	6	50	4
	UTE504 01001016	1	1	16	50	4	UTE504 01500508	1.5	0.5	8	50	4
	UTE504 01001516	1	1.5	16	50	4	UTE504 01501008	1.5	1	8	50	4
U-Wing	UTE504 01002016	1	2	16	50	4	UTE504 01501508	1.5	1.5	8	50	4
	UTE504 01003016	1	3	16	50	4	UTE504 01502008	1.5	2	8	50	4
	UTE504 01200506	1.2	0.5	6	50	4	UTE504 01503008	1.5	3	8	50	4
Zamus Thunder	UTE504 01201006	1.2	1	6	50	4	UTE504 01500510	1.5	0.5	10	50	4
	UTE504 01201506	1.2	1.5	6	50	4	UTE504 01501010	1.5	1	10	50	4
	UTE504 01202006	1.2	2	6	50	4	UTE504 01501510	1.5	1.5	10	50	4
	UTE504 01203006	1.2	3	6	50	4	UTE504 01502010	1.5	2	10	50	4
X-Star	UTE504 01200508	1.2	0.5	8	50	4	UTE504 01503010	1.5	3	10	50	4
	UTE504 01201008	1.2	1	8	50	4	UTE504 01500512	1.5	0.5	12	50	4
	UTE504 01201508	1.2	1.5	8	50	4	UTE504 01501012	1.5	1	12	50	4
	UTE504 01202008	1.2	2	8	50	4	UTE504 01501512	1.5	1.5	12	50	4
S-Wing	UTE504 01203008	1.2	3	8	50	4	UTE504 01502012	1.5	2	12	50	4
	UTE504 01200510	1.2	0.5	10	50	4	UTE504 01503012	1.5	3	12	50	4
	UTE504 01201010	1.2	1	10	50	4	UTE504 01500516	1.5	0.5	16	50	4
A-Wing	UTE504 01201510	1.2	1.5	10	50	4	UTE504 01501016	1.5	1	16	50	4
	UTE504 01202010	1.2	2	10	50	4	UTE504 01501516	1.5	1.5	16	50	4
	UTE504 01203010	1.2	3	10	50	4	UTE504 01502016	1.5	2	16	50	4
Standard	UTE504 01200512	1.2	0.5	12	50	4	UTE504 01503016	1.5	3	16	50	4
	UTE504 01201512	1.2	1.5	12	50	4	UTE504 01500520	1.5	0.5	20	60	4
	UTE504 01201012	1.2	1	12	50	4	UTE504 01501020	1.5	1	20	60	4
	UTE504 01202012	1.2	2	12	50	4	UTE504 01501520	1.5	1.5	20	60	4
Copper-Mate	UTE504 01203012	1.2	3	12	50	4	UTE504 01502020	1.5	2	20	60	4
	UTE504 01200516	1.2	0.5	16	50	4	UTE504 01503020	1.5	3	20	60	4
	UTE504 01201016	1.2	1	16	50	4	UTE504 02000508	2	0.5	8	50	4
Gra-Mate	UTE504 01201516	1.2	1.5	16	50	4	UTE504 02001008	2	1	8	50	4
	UTE504 01202016	1.2	2	16	50	4	UTE504 02001508	2	1.5	8	50	4

▶ 적용 피삭재

○ : 적합 ◎ : 매우 적합

H		P			K	N			M	S
열처리강		탄소강	합금강	프리하든강	주철	동	흑연	알루미늄	스테인리스	내열합금
SKD61 ~HRc55	SKD11 HRc55~	~HB225	HB225 ~325	HRc30~50	~FCD500					
○		○	◎	◎	○					

UTE504 4날 테이퍼 스퀘어 엔드밀

Endmill

품목코드	DC	BHTA	APMX	OAL	DCONMS	품목코드	DC	BHTA	APMX	OAL	DCONMS
	날경	테이퍼각	날장	전장	자루경		날경	테이퍼각	날장	전장	자루경
UTE504 02002008	2	2	8	50	4	UTE504 02501012	2.5	1	12	50	4
UTE504 02003008	2	3	8	50	4	UTE504 02502012	2.5	2	12	50	4
UTE504 02000510	2	0.5	10	50	4	UTE504 02503012	2.5	3	12	50	4
UTE504 02001010	2	1	10	50	4	UTE504 02500516	2.5	0.5	16	50	4
UTE504 02001510	2	1.5	10	50	4	UTE504 02501016	2.5	1	16	50	4
UTE504 02002010	2	2	10	50	4	UTE504 02501516	2.5	1.5	16	50	4
UTE504 02003010	2	3	10	50	4	UTE504 02502016	2.5	2	16	50	4
UTE504 02000512	2	0.5	12	50	4	UTE504 02503016	2.5	3	16	50	6
UTE504 02001012	2	1	12	50	4	UTE504 02500520	2.5	0.5	20	60	4
UTE504 02001512	2	1.5	12	50	4	UTE504 02501020	2.5	1	20	60	4
UTE504 02002012	2	2	12	50	4	UTE504 02501520	2.5	1.5	20	60	4
UTE504 02003012	2	3	12	50	4	UTE504 02502020	2.5	2	20	60	4
UTE504 02000516	2	0.5	16	50	4	UTE504 02503020	2.5	3	20	60	6
UTE504 02001016	2	1	16	50	4	UTE504 02500525	2.5	0.5	25	60	4
UTE504 02001516	2	1.5	16	50	4	UTE504 02501025	2.5	1	25	60	4
UTE504 02002016	2	2	16	50	4	UTE504 02501525	2.5	1.5	25	60	4
UTE504 02003016	2	3	16	50	4	UTE504 02502025	2.5	2	25	60	6
UTE504 02000520	2	0.5	20	60	4	UTE504 02503025	2.5	3	25	60	6
UTE504 02001020	2	1	20	60	4	UTE504 02500530	2.5	0.5	30	60	4
UTE504 02001520	2	1.5	20	60	4	UTE504 02501030	2.5	1	30	60	4
UTE504 02002020	2	2	20	60	4	UTE504 02501530	2.5	1.5	30	60	6
UTE504 02003020	2	3	20	60	6	UTE504 02502030	2.5	2	30	60	6
UTE504 02000525	2	0.5	25	60	4	UTE504 02503030	2.5	3	30	60	6
UTE504 02001025	2	1	25	60	4	UTE504 030005	3	0.5	12	50	6
UTE504 02001525	2	1.5	25	60	4	UTE504 03001	3	1	12	50	6
UTE504 02002025	2	2	25	60	4	UTE504 030015	3	1.5	12	50	6
UTE504 02003025	2	3	25	60	6	UTE504 03002	3	2	14	50	6
UTE504 02500510	2.5	0.5	10	50	4	UTE504 03003	3	3	14	50	6
UTE504 02501010	2.5	1	10	50	4	UTE504 03005	3	5	16	50	6
UTE504 02501510	2.5	1.5	10	50	4	UTE504 03007	3	7	16	50	8
UTE504 02502010	2.5	2	10	50	4	UTE504 03010	3	10	16	50	10
UTE504 02503010	2.5	3	10	50	4	UTE504 040005	4	0.5	16	60	6
UTE504 02500512	2.5	0.5	12	50	4	UTE504 04001	4	1	16	60	6
UTE504 02501512	2.5	1.5	12	50	4	UTE504 040015	4	1.5	16	60	6

Zamus Star
E-Star
U-Wing
Zamus Thunder
X-Star
S-Wing
A-Wing
Standard
Copper-Mate
Gra-Mate

▶ 적용 피삭재

○ : 적합 ◎ : 매우 적합

H		P			K	N			M	S
열처리강		탄소강	합금강	프리하든강	주철	동	흑연	알루미늄	스테인리스	내열합금
SKD61 ~HRc55	SKD11 HRc55~	~HB225	HB225 ~325	HRc30~50	~FCD500					
○		○	◎	◎	○					

UTE504 4날 테이퍼 스퀘어 엔드밀

Endmill

품목코드	DC	BHTA	APMX	OAL	DCONMS	품목코드	DC	BHTA	APMX	OAL	DCONMS
	날경	테이퍼각	날장	전장	자루경		날경	테이퍼각	날장	전장	자루경
UTE504 04002	4	2	16	60	6	UTE504 07005	7	5	28	80	12
UTE504 04003	4	3	19	60	6	UTE504 080005	8	0.5	35	90	10
UTE504 04005	4	5	22	65	8	UTE504 08001	8	1	35	90	10
UTE504 04007	4	7	16	65	8	UTE504 080015	8	1.5	35	90	10
UTE504 04010	4	10	17	65	10	UTE504 08002	8	2	28	90	10
UTE504 060005	6	0.5	20	65	8	UTE504 08003	8	3	38	90	12
UTE504 06001	6	1	20	65	8	UTE504 08005	8	5	45	100	16
UTE504 060015	6	1.5	20	65	8	UTE504 08007	8	7	32	90	16
UTE504 06002	6	2	20	65	8	UTE504 08010	8	10	34	100	20
UTE504 06003	6	3	19	65	8	UTE504 100005	10	0.5	40	90	12
UTE504 06005	6	5	22	75	10	UTE504 10001	10	1	40	90	12
UTE504 06007	6	7	24	75	12	UTE504 100015	10	1.5	38	90	12
UTE504 06010	6	10	17	75	12	UTE504 10002	10	2	40	90	16
UTE504 070005	7	0.5	28	70	8	UTE504 10003	10	3	40	100	16
UTE504 07001	7	1	28	70	8	UTE504 10005	10	5	34	100	16
UTE504 070015	7	1.5	28	70	10	UTE504 10007	10	7	40	90	20
UTE504 07002	7	2	28	80	10	UTE504 10010	10	10	42	100	25
UTE504 07003	7	3	28	80	10						

Zamus Star

E-Star

U-Wing

Zamus Thunder

X-Star

S-Wing

A-Wing

Standard

Copper -Mate

Gra -Mate

▶ 적용 피삭재

○ : 적합 ◎ : 매우 적합

H		P			K	N			M	S
열처리강		탄소강	합금강	프리하든강	주철	동	흑연	알루미늄	스테인리스	내열합금
SKD61 ~HRc55	SKD11 HRc55~	~HB225	HB225 ~325	HRc30~50	~FCD500					
○		○	◎	◎	○					

UR502 2날 라디우스 엔드밀

Endmill

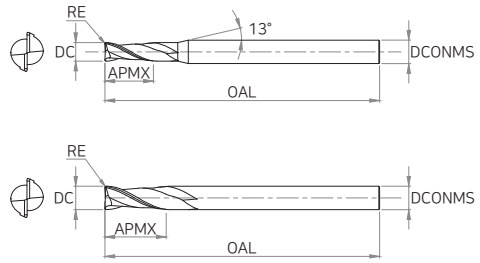

▶ 제품허용공차

날경(DC)		자루경
∅0.2 ~ ∅6	0 ~ -0.012	
∅7 ~ ∅20	0 ~ -0.015	

h5

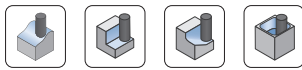

CARBIDE
AlCrN
2
30° HELIX
R ±0.01
R ±0.015
절삭조건 P.691

R6 이하 R6 초과

품목코드	DC	RE	APMX	OAL	DCONMS	품목코드	DC	RE	APMX	OAL	DCONMS
	날경	Corner R	날장	전장	자루경		날경	Corner R	날장	전장	자루경
UR502 002002	0.2	0.02	0.4	40	4	UR502 01001	1	0.1	2.5	50	6
UR502 002005	0.2	0.05	0.4	40	4	UR502 01002	1	0.2	2.5	50	6
UR502 003002	0.3	0.02	0.6	40	4	UR502 01003	1	0.3	2.5	50	6
UR502 003005	0.3	0.05	0.6	40	4	UR502 012005	1.2	0.05	3	50	6
UR502 004005	0.4	0.05	0.8	40	4	UR502 01201	1.2	0.1	3	50	6
UR502 00401	0.4	0.1	0.8	40	4	UR502 01202	1.2	0.2	3	50	6
UR502 005005	0.5	0.05	1	40	4	UR502 01203	1.2	0.3	3	50	6
UR502 00501	0.5	0.1	1	40	4	UR502 015005	1.5	0.05	4	50	6
UR502 006005	0.6	0.05	1.2	40	4	UR502 01501	1.5	0.1	4	50	6
UR502 00601	0.6	0.1	1.2	40	4	UR502 01502	1.5	0.2	4	50	6
UR502 00602	0.6	0.2	1.2	40	4	UR502 01503	1.5	0.3	4	50	6
UR502 007005	0.7	0.05	1.4	40	4	UR502 01505	1.5	0.5	4	50	6
UR502 00701	0.7	0.1	1.4	40	4	UR502 02001	2	0.1	6	50	6
UR502 00702	0.7	0.2	1.4	40	4	UR502 02002	2	0.2	6	50	6
UR502 008005	0.8	0.05	1.6	40	4	UR502 02003	2	0.3	6	50	6
UR502 00801	0.8	0.1	1.6	40	4	UR502 02005	2	0.5	6	50	6
UR502 00802	0.8	0.2	1.6	40	4	UR502 02501	2.5	0.1	7	60	6
UR502 009005	0.9	0.05	1.8	40	4	UR502 02502	2.5	0.2	7	60	6
UR502 00901	0.9	0.1	1.8	40	4	UR502 02503	2.5	0.3	7	60	6
UR502 010005	1	0.05	2.5	50	6	UR502 02505	2.5	0.5	7	60	6

▶ 적용 피삭재

○ : 적합 ◎ : 매우 적합

H		P			K	N			M	S
열처리강		탄소강	합금강	프리하든강	주철	동	흑연	알루미늄	스테인리스	내열합금
SKD61 ~HRc55	SKD11 HRc55~	~HB225	HB225 ~325	HRc30~50	~FCD500					
○		○	◎	◎	○					

Zamus Star

E-Star

U-Wing

Zamus Thunder

X-Star

S-Wing

A-Wing

Standard

Copper-Mate

Gra-Mate

UR502 2날 라디우스 엔드밀

Endmill

종류	품목코드	DC	RE	APMX	OAL	DCONMS	품목코드	DC	RE	APMX	OAL	DCONMS
		날경	Corner R	날장	전장	자루경		날경	Corner R	날장	전장	자루경
Zamus Star	UR502 03001	3	0.1	8	60	6	UR502 05503	5.5	0.3	13	90	6
	UR502 03002	3	0.2	8	60	6	UR502 05505	5.5	0.5	13	90	6
	UR502 03003	3	0.3	8	60	6	UR502 05510	5.5	1	13	90	6
	UR502 03005	3	0.5	8	60	6	UR502 06001	6	0.1	15	90	6
	UR502 03010	3	1	8	60	6	UR502 06002	6	0.2	15	90	6
E-Star	UR502 03501	3.5	0.1	10	70	6	UR502 06003	6	0.3	15	90	6
	UR502 03502	3.5	0.2	10	70	6	UR502 0600360	6	0.3	15	60	6
	UR502 03503	3.5	0.3	10	70	6	UR502 06005	6	0.5	15	90	6
U-Wing	UR502 03505	3.5	0.5	10	70	6	UR502 06005110	6	0.5	15	110	6
	UR502 04001	4	0.1	10	70	6	UR502 06005130	6	0.5	15	130	6
	UR502 04001100S4	4	0.1	10	100	4	UR502 0600560	6	0.5	15	60	6
	UR502 04001S4	4	0.1	10	70	4	UR502 06010	6	1	15	90	6
Zamus Thunder	UR502 04002	4	0.2	10	70	6	UR502 06010110	6	1	15	110	6
	UR502 04002100S4	4	0.2	10	100	4	UR502 06010130	6	1	15	130	6
	UR502 04002S4	4	0.2	10	70	4	UR502 0601060	6	1	15	60	6
X-Star	UR502 04003	4	0.3	10	70	6	UR502 06015	6	1.5	15	90	6
	UR502 04003100S4	4	0.3	10	100	4	UR502 06020	6	2	15	90	6
	UR502 04003S4	4	0.3	10	70	4	UR502 07001	7	0.1	16	90	8
	UR502 04005	4	0.5	10	70	6	UR502 07002	7	0.2	16	90	8
	UR502 04005100S4	4	0.5	10	100	4	UR502 07003	7	0.3	16	90	8
S-Wing	UR502 04005S4	4	0.5	10	70	4	UR502 07005	7	0.5	16	90	8
	UR502 04010	4	1	10	70	6	UR502 07010	7	1	16	90	8
	UR502 04010100S4	4	1	10	100	4	UR502 07020	7	2	16	90	8
A-Wing	UR502 04010S4	4	1	10	70	4	UR502 08001	8	0.1	20	100	8
	UR502 04501	4.5	0.1	11	80	6	UR502 08002	8	0.2	20	100	8
Standard	UR502 04502	4.5	0.2	11	80	6	UR502 08003	8	0.3	20	100	8
	UR502 04503	4.5	0.3	11	80	6	UR502 0800370	8	0.3	20	70	8
	UR502 04505	4.5	0.5	11	80	6	UR502 08005	8	0.5	20	100	8
	UR502 05001	5	0.1	13	90	6	UR502 08005120	8	0.5	20	120	8
	UR502 05002	5	0.2	13	90	6	UR502 08005150	8	0.5	20	150	8
Copper-Mate	UR502 05003	5	0.3	13	90	6	UR502 0800570	8	0.5	20	70	8
	UR502 05005	5	0.5	13	90	6	UR502 08010	8	1	20	100	8
	UR502 05010	5	1	13	90	6	UR502 08010120	8	1	20	120	8
Gra-Mate	UR502 05501	5.5	0.1	13	90	6	UR502 08010150	8	1	20	150	8
	UR502 05502	5.5	0.2	13	90	6	UR502 0801070	8	1	20	70	8

▶ 적용 피삭재

○ : 적합 ◎ : 매우 적합

H		P			K	N			M	S
열처리강		탄소강	합금강	프리하든강	주철	동	흑연	알루미늄	스테인리스	내열합금
SKD61 ~HRc55	SKD11 HRc55~	~HB225	HB225 ~325	HRc30~50	~FCD500					
○		○	◎	◎	○					

UR502 2날 라디우스 엔드밀

Endmill

품목코드	DC	RE	APMX	OAL	DCONMS	품목코드	DC	RE	APMX	OAL	DCONMS
	날경	Corner R	날장	전장	자루경		날경	Corner R	날장	전장	자루경
UR502 08015	8	1.5	20	100	8	UR502 04010S4	4	1	10	70	4
UR502 08020	8	2	20	100	8	UR502 04501	4.5	0.1	11	80	6
UR502 08025	8	2.5	20	100	8	UR502 04502	4.5	0.2	11	80	6
UR502 08003	8	3	20	100	8	UR502 04503	4.5	0.3	11	80	6
UR502 10001	10	0.1	25	100	10	UR502 04505	4.5	0.5	11	80	6
UR502 10002	10	0.2	25	100	10	UR502 05001	5	0.1	13	90	6
UR502 10003	10	0.3	25	100	10	UR502 05002	5	0.2	13	90	6
UR502 1000375	10	0.3	25	75	10	UR502 05003	5	0.3	13	90	6
UR502 10005	10	0.5	25	100	10	UR502 05005	5	0.5	13	90	6
UR502 10005130	10	0.5	25	130	10	UR502 05010	5	1	13	90	6
UR502 10005150	10	0.5	25	150	10	UR502 05501	5.5	0.1	13	90	6
UR502 1000575	10	0.5	25	75	10	UR502 05502	5.5	0.2	13	90	6
UR502 10010	10	1	25	100	10	UR502 05503	5.5	0.3	13	90	6
UR502 10010130	10	1	25	130	10	UR502 05505	5.5	0.5	13	90	6
UR502 10010150	10	1	25	150	10	UR502 05510	5.5	1	13	90	6
UR502 1001075	10	1	25	75	10	UR502 06001	6	0.1	15	90	6
UR502 10015	10	1.5	25	100	10	UR502 06002	6	0.2	15	90	6
UR502 10020	10	2	25	100	10	UR502 06003	6	0.3	15	90	6
UR502 10025	10	2.5	25	100	10	UR502 0600360	6	0.3	15	60	6
UR502 10030	10	3	25	100	10	UR502 06005	6	0.5	15	90	6
UR502 03505	3.5	0.5	10	70	6	UR502 06005110	6	0.5	15	110	6
UR502 04001	4	0.1	10	70	6	UR502 06005130	6	0.5	15	130	6
UR502 04001100S4	4	0.1	10	100	4	UR502 0600560	6	0.5	15	60	6
UR502 04001S4	4	0.1	10	70	4	UR502 06010	6	1	15	90	6
UR502 04002	4	0.2	10	70	6	UR502 06010110	6	1	15	110	6
UR502 04002100S4	4	0.2	10	100	4	UR502 06010130	6	1	15	130	6
UR502 04002S4	4	0.2	10	70	4	UR502 0601060	6	1	15	60	6
UR502 04003	4	0.3	10	70	6	UR502 06015	6	1.5	15	90	6
UR502 04003100S4	4	0.3	10	100	4	UR502 06020	6	2	15	90	6
UR502 04003S4	4	0.3	10	70	4	UR502 07001	7	0.1	16	90	8
UR502 04005	4	0.5	10	70	6	UR502 07002	7	0.2	16	90	8
UR502 04005100S4	4	0.5	10	100	4	UR502 07003	7	0.3	16	90	8
UR502 04005S4	4	0.5	10	70	4	UR502 07005	7	0.5	16	90	8
UR502 04010	4	1	10	70	6	UR502 07010	7	1	16	90	8
UR502 04010100S4	4	1	10	100	4	UR502 07020	7	2	16	90	8

Zamus Star
E-Star
U-Wing
Zamus Thunder
X-Star
S-Wing
A-Wing
Standard
Copper-Mate
Gra-Mate

▶ 적용 피삭재

○ : 적합 ◎ : 매우 적합

H		P			K	N			M	S
열처리강		탄소강	합금강	프리하든강	주철	동	흑연	알루미늄	스테인리스	내열합금
SKD61 ~HRc55	SKD11 HRc55~	~HB225	HB225 ~325	HRc30~50	~FCD500					
○		○	◎	◎	○					

UR502 2날 라디우스 엔드밀

Endmill

	품목코드						품목코드					
	DC 날경	RE Corner R	APMX 날장	OAL 전장	DCONMS 자루경		DC 날경	RE Corner R	APMX 날장	OAL 전장	DCONMS 자루경	
Zamus Star	UR502 08001	8	0.1	20	100	8	UR502 11005	11	0.5	25	110	12
	UR502 08002	8	0.2	20	100	8	UR502 11010	11	1	25	110	12
	UR502 08003	8	0.3	20	100	8	UR502 11020	11	2	25	110	12
	UR502 0800370	8	0.3	20	70	8	UR502 12001	12	0.1	30	110	12
	UR502 08005	8	0.5	20	100	8	UR502 12002	12	0.2	30	110	12
E-Star	UR502 08005120	8	0.5	20	120	8	UR502 12003	12	0.3	30	110	12
	UR502 08005150	8	0.5	20	150	8	UR502 1200380	12	0.3	30	80	12
	UR502 0800570	8	0.5	20	70	8	UR502 12005	12	0.5	30	110	12
U-Wing	UR502 08010	8	1	20	100	8	UR502 12005130	12	0.5	30	130	12
	UR502 08010120	8	1	20	120	8	UR502 12005150	12	0.5	30	150	12
	UR502 08010150	8	1	20	150	8	UR502 1200580	12	0.5	30	80	12
	UR502 0801070	8	1	20	70	8	UR502 12010	12	1	30	110	12
Zamus Thunder	UR502 08015	8	1.5	20	100	8	UR502 12010130	12	1	30	130	12
	UR502 08020	8	2	20	100	8	UR502 12010150	12	1	30	150	12
	UR502 08025	8	2.5	20	100	8	UR502 1201080	12	1	30	80	12
	UR502 08030	8	3	20	100	8	UR502 12015	12	1.5	30	110	12
X-Star	UR502 10001	10	0.1	25	100	10	UR502 12020	12	2	30	110	12
	UR502 10002	10	0.2	25	100	10	UR502 12025	12	2.5	30	110	12
	UR502 10003	10	0.3	25	100	10	UR502 12030	12	3	30	110	12
	UR502 1000375	10	0.3	25	75	10	UR502 12040	12	4	30	110	12
S-Wing	UR502 10005	10	0.5	25	100	10	UR502 12050	12	5	30	110	12
	UR502 10005130	10	0.5	25	130	10	UR502 14005	14	0.5	30	150	16
	UR502 10005150	10	0.5	25	150	10	UR502 14010	14	1	30	150	16
A-Wing	UR502 1000575	10	0.5	25	75	10	UR502 14020	14	2	30	150	16
	UR502 10010	10	1	25	100	10	UR502 16005	16	0.5	32	150	16
	UR502 10010130	10	1	25	130	10	UR502 16010	16	1	32	150	16
Standard	UR502 10010150	10	1	25	150	10	UR502 16015	16	1.5	32	150	16
	UR502 1001075	10	1	25	75	10	UR502 16020	16	2	32	150	16
	UR502 10015	10	1.5	25	100	10	UR502 16030	16	3	32	150	16
	UR502 10020	10	2	25	100	10	UR502 20005	20	0.5	38	150	20
Copper-Mate	UR502 10025	10	2.5	25	100	10	UR502 20010	20	1	38	150	20
	UR502 10030	10	3	25	100	10	UR502 20015	20	1.5	38	150	20
	UR502 10040	10	4	25	100	10	UR502 20020	20	2	38	150	20
Gra-Mate	UR502 11002	11	0.2	25	110	12	UR502 20030	20	3	38	150	20
	UR502 11003	11	0.3	25	110	12						

▶ 적용 피삭재

○ : 적합 ◎ : 매우 적합

H		P			K	N			M	S
열처리강		탄소강	합금강	프리하든강	주철	동	흑연	알루미늄	스테인리스	내열합금
SKD61 ~HRc55	SKD11 HRc55~	~HB225	HB225 ~325	HRc30~50	~FCD500					
○		○	◎	◎	○					

UR504 4날 래디우스 엔드밀

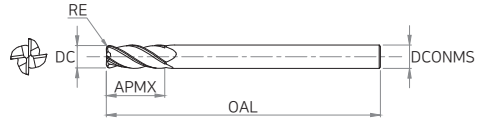
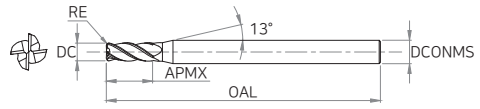

▶ 제품허용공차

날경(DC)		자루경
Ø3 ~ Ø20	0 ~ -0.03	h5

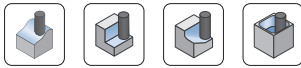

품목코드	DC	RE	APMX	OAL	DCONMS
	날경	Corner R	날장	전장	자루경
UR504 03002	3	0.2	8	60	6
UR504 03002S4	3	0.2	8	60	4
UR504 03003	3	0.3	8	60	6
UR504 03005	3	0.5	8	60	6
UR504 03005S4	3	0.5	8	60	4
UR504 04002	4	0.2	10	70	6
UR504 04002S4	4	0.2	10	70	4
UR504 04003	4	0.3	10	70	6
UR504 04005	4	0.5	10	70	6
UR504 04005S4	4	0.5	10	70	4
UR504 04010	4	1	10	70	6
UR504 04010S4	4	1	10	70	4
UR504 05002	5	0.2	13	90	6
UR504 05003	5	0.3	13	90	6
UR504 05003060	5	0.3	13	60	6
UR504 05005	5	0.5	13	90	6
UR504 05005060	5	0.5	13	60	6
UR504 05010	5	1	13	90	6
UR504 06002	6	0.2	13	90	6
UR504 06003	6	0.3	15	90	6

품목코드	DC	RE	APMX	OAL	DCONMS
	날경	Corner R	날장	전장	자루경
UR504 06003060	6	0.3	15	60	6
UR504 06005	6	0.5	15	90	6
UR504 06005060	6	0.5	15	60	6
UR504 06010	6	1	15	90	6
UR504 06010060	6	1	15	60	6
UR504 08003	8	0.3	20	100	8
UR504 08003070	8	0.3	20	70	8
UR504 08005	8	0.5	20	100	8
UR504 08005070	8	0.5	20	70	8
UR504 08010	8	1	20	100	8
UR504 08010070	8	1	20	70	8
UR504 08015	8	1.5	20	100	8
UR504 08020	8	2	20	100	8
UR504 10003	10	0.3	25	100	10
UR504 10003075	10	0.3	25	75	10
UR504 10005	10	0.5	25	100	10
UR504 1000575	10	0.5	25	75	10
UR504 10010	10	1	25	100	10
UR504 10010075	10	1	25	75	10
UR504 10015	10	1.5	25	100	10

▶ 적용 피삭재

○ : 적합 ◎ : 매우 적합

H		P			K	N			M	S
열처리강		탄소강	합금강	프리하든강	주철	동	흑연	알루미늄	스테인리스	내열합금
SKD61 ~HRC55	SKD11 HRC55~	~HB225	HB225 ~325	HRC30~50	~FCD500					
○		○	◎	◎	○					

UR504 4날 라디우스 엔드밀

Endmill

Zamus Star

E-Star

U-Wing

Zamus Thunder

X-Star

S-Wing

A-Wing

Standard

Copper -Mate

Gra -Mate

품목코드	DC	RE	APMX	OAL	DCONMS	품목코드	DC	RE	APMX	OAL	DCONMS
	날경	Corner R	날장	전장	자루경		날경	Corner R	날장	전장	자루경
UR504 10020	10	2	25	100	10	UR504 16010	16	1	32	150	16
UR504 10025	10	2.5	25	100	10	UR504 16010100	16	1	32	100	16
UR504 12003	12	0.3	30	110	12	UR504 16015	16	1.5	32	150	16
UR504 12003080	12	0.3	30	80	12	UR504 16015100	16	1.5	32	100	16
UR504 12005	12	0.5	30	110	12	UR504 16020	16	2	32	150	16
UR504 12005080	12	0.5	30	80	12	UR504 16020100	16	2	32	100	16
UR504 12010	12	1	30	110	12	UR504 20005	20	0.5	38	150	20
UR504 12010080	12	1	30	80	12	UR504 20005100	20	0.5	38	100	20
UR504 12015	12	1.5	30	110	12	UR504 20010	20	1	38	150	20
UR504 12020	12	2	30	110	12	UR504 20010100	20	1	38	100	20
UR504 12025	12	2.5	30	110	12	UR504 20015	20	1.5	38	150	20
UR504 12030	12	3	30	110	12	UR504 20015100	20	1.5	38	100	20
UR504 16005	16	0.5	32	150	16	UR504 20020	20	2	38	150	20
UR504 16005100	16	0.5	32	100	16	UR504 20020100	20	2	38	100	20

▶ 적용 피삭재

○ : 적합 ◎ : 매우 적합

H		P			K	N			M	S
열처리강		탄소강	합금강	프리하든강	주철	동	흑연	알루미늄	스테인리스	내열합금
SKD61 ~HRc55	SKD11 HRc55~	~HB225	HB225 ~325	HRc30~50	~FCD500					
○		○	◎	◎	○					

UR506 6날 래디우스 엔드밀

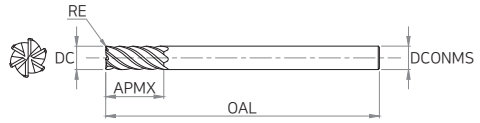

Endmill

▶ 제품허용공차

날경(DC)		자루경
∅6 ~ ∅20	0 ~ -0.03	h5

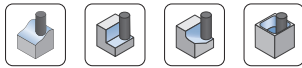

CARBIDE
AlCrN
6
45° HELIX
R ±0.015
절삭조건 P.692

품목코드	DC	RE	APMX	OAL	DCONMS
	날경	Corner R	날장	전장	자루경
UR506 06003	6	0.3	15	90	6
UR506 06005	6	0.5	15	90	6
UR506 06010	6	1	15	90	6
UR506 08003	8	0.3	20	100	8
UR506 08005	8	0.5	20	100	8
UR506 08010	8	1	20	100	8
UR506 10003	10	0.3	25	100	10
UR506 10005	10	0.5	25	100	10
UR506 10010	10	1	25	100	10
UR506 12003	12	0.3	30	110	12
UR506 12005	12	0.5	30	110	12
UR506 12010	12	1	30	110	12
UR506 16005	16	0.5	32	150	16
UR506 16010	16	1	32	150	16
UR506 16015	16	1.5	32	150	16
UR506 16020	16	2	32	150	16
UR506 20005	20	0.5	38	150	20
UR506 20010	20	1	38	150	20
UR506 20015	20	1.5	38	150	20
UR506 20020	20	2	38	150	20

▶ 적용 피삭재

○ : 적합 ◎ : 매우 적합

H		P			K	N			M	S
열처리강		탄소강	합금강	프리하트강	주철	동	흑연	알루미늄	스테인리스	내열합금
SKD61 ~HRC55	SKD11 HRC55~	~HB225	HB225 ~325	HRC30~50	~FCD500					
○		○	◎	◎	○					

Zamus Star

E-Star

U-Wing

Zamus Thunder

X-Star

S-Wing

A-Wing

Standard

Copper-Mate

Gra-Mate

UR512 2날 벡타입 래디우스 엔드밀

Endmill

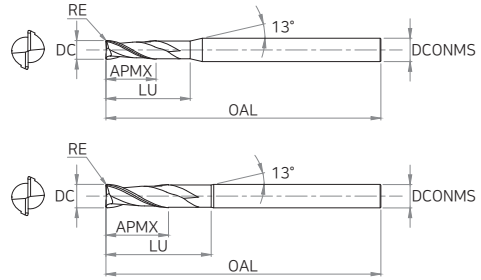

▶ 제품허용공차

날경(DC)		자루경
∅0.2 ~ ∅6	0 ~ -0.012	h5
∅8 ~ ∅20	0 ~ -0.015	

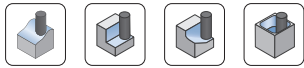

품목코드	DC	RE	APMX	LU	OAL	DCONMS	품목코드	DC	RE	APMX	LU	OAL	DCONMS
	날경	Corner R	날장	유효장	전장	자루경		날경	Corner R	날장	유효장	전장	자루경
UR512 002002005	0.2	0.02	0.3	0.5	40	4	UR512 0040101	0.4	0.1	0.6	1	40	4
UR512 00200201	0.2	0.02	0.3	1	40	4	UR512 00401015	0.4	0.1	0.6	1.5	40	4
UR512 002002015	0.2	0.02	0.3	1.5	40	4	UR512 0040102	0.4	0.1	0.6	2	40	4
UR512 00200202	0.2	0.02	0.3	2	40	4	UR512 00401025	0.4	0.1	0.6	2.5	40	4
UR512 002005005	0.2	0.05	0.3	0.5	40	4	UR512 0040103	0.4	0.1	0.6	3	40	4
UR512 00200501	0.2	0.05	0.3	1	40	4	UR512 0040104	0.4	0.1	0.6	4	40	4
UR512 002005015	0.2	0.05	0.3	1.5	40	4	UR512 00500501	0.5	0.05	0.7	1	45	4
UR512 00200502	0.2	0.05	0.3	2	40	4	UR512 005005015	0.5	0.05	0.7	1.5	45	4
UR512 00300201	0.3	0.02	0.5	1	40	4	UR512 00500502	0.5	0.05	0.7	2	45	4
UR512 00300202	0.3	0.02	0.5	2	40	4	UR512 005005025	0.5	0.05	0.7	2.5	45	4
UR512 00300203	0.3	0.02	0.5	3	40	4	UR512 00500503	0.5	0.05	0.7	3	45	4
UR512 00300501	0.3	0.05	0.5	1	40	4	UR512 00500504	0.5	0.05	0.7	4	45	4
UR512 00300502	0.3	0.05	0.5	2	40	4	UR512 00500505	0.5	0.05	0.7	5	45	4
UR512 00300503	0.3	0.05	0.5	3	40	4	UR512 00500506	0.5	0.05	0.7	6	45	4
UR512 00400501	0.4	0.05	0.6	1	40	4	UR512 0050101	0.5	0.1	0.7	1	45	4
UR512 004005015	0.4	0.05	0.6	1.5	40	4	UR512 00501015	0.5	0.1	0.7	1.5	45	4
UR512 00400502	0.4	0.05	0.6	2	40	4	UR512 0050102	0.5	0.1	0.7	2	45	4
UR512 004005025	0.4	0.05	0.6	2.5	40	4	UR512 00501025	0.5	0.1	0.7	2.5	45	4
UR512 00400503	0.4	0.05	0.6	3	40	4	UR512 0050103	0.5	0.1	0.7	3	45	4
UR512 00400504	0.4	0.05	0.6	4	40	4	UR512 0050104	0.5	0.1	0.7	4	45	4

▶ 적용 피삭재

○ : 적합 ◎ : 매우 적합

H		P			K	N		M	S	
열처리강		탄소강	합금강	프리하든강	주철	동	흑연	알루미늄	스테인리스	내열합금
SKD61 ~HRc55	SKD11 HRc55~	~HB225	HB225 ~325	HRc30~50	~FCD500					
○		○	◎	◎	○					

UR512 2날 벡타입 래디우스 엔드밀

Endmill

품목코드	DC	RE	APMX	LU	OAL	DCONMS	품목코드	DC	RE	APMX	LU	OAL	DCONMS
	날경	Corner R	날장	유효장	전장	자루경		날경	Corner R	날장	유효장	전장	자루경
UR512 0050105	0.5	0.1	0.7	5	45	4	UR512 0070210	0.7	0.2	1.2	10	45	4
UR512 0050106	0.5	0.1	0.7	6	45	4	UR512 00800502	0.8	0.05	1.2	2	45	4
UR512 00600502	0.6	0.05	0.9	2	45	4	UR512 00800503	0.8	0.05	1.2	3	45	4
UR512 00600503	0.6	0.05	0.9	3	45	4	UR512 00800504	0.8	0.05	1.2	4	45	4
UR512 00600504	0.6	0.05	0.9	4	45	4	UR512 00800506	0.8	0.05	1.2	6	45	4
UR512 00600506	0.6	0.05	0.9	6	45	4	UR512 00800508	0.8	0.05	1.2	8	45	4
UR512 00600508	0.6	0.05	0.9	8	45	4	UR512 00800510	0.8	0.05	1.2	10	45	4
UR512 00600510	0.6	0.05	0.9	10	45	4	UR512 0080102	0.8	0.1	1.2	2	45	4
UR512 0060102	0.6	0.1	0.9	2	45	4	UR512 0080103	0.8	0.1	1.2	3	45	4
UR512 0060103	0.6	0.1	0.9	3	45	4	UR512 0080104	0.8	0.1	1.2	4	45	4
UR512 0060104	0.6	0.1	0.9	4	45	4	UR512 0080106	0.8	0.1	1.2	6	45	4
UR512 0060106	0.6	0.1	0.9	6	45	4	UR512 0080108	0.8	0.1	1.2	8	45	4
UR512 0060108	0.6	0.1	0.9	8	45	4	UR512 0080110	0.8	0.1	1.2	10	45	4
UR512 0060110	0.6	0.1	0.9	10	45	4	UR512 0080202	0.8	0.2	1.2	2	45	4
UR512 0060202	0.6	0.2	0.9	2	45	4	UR512 0080203	0.8	0.2	1.2	3	45	4
UR512 0060203	0.6	0.2	0.9	3	45	4	UR512 0080204	0.8	0.2	1.2	4	45	4
UR512 0060204	0.6	0.2	0.9	4	45	4	UR512 0080206	0.8	0.2	1.2	6	45	4
UR512 0060206	0.6	0.2	0.9	6	45	4	UR512 0080208	0.8	0.2	1.2	8	45	4
UR512 0060208	0.6	0.2	0.9	8	45	4	UR512 0080210	0.8	0.2	1.2	10	45	4
UR512 0060210	0.6	0.2	0.9	10	45	4	UR512 01000503	1	0.05	1.5	3	50	4
UR512 00700502	0.7	0.05	1.2	2	45	4	UR512 01000504	1	0.05	1.5	4	50	4
UR512 00700504	0.7	0.05	1.2	4	45	4	UR512 01000506	1	0.05	1.5	6	50	4
UR512 00700506	0.7	0.05	1.2	6	45	4	UR512 01000508	1	0.05	1.5	8	50	4
UR512 00700508	0.7	0.05	1.2	8	45	4	UR512 01000510	1	0.05	1.5	10	50	4
UR512 00700510	0.7	0.05	1.2	10	45	4	UR512 01000512	1	0.05	1.5	12	50	4
UR512 0070102	0.7	0.1	1.2	2	45	4	UR512 01000514	1	0.05	1.5	14	50	4
UR512 0070104	0.7	0.1	1.2	4	45	4	UR512 01000516	1	0.05	1.5	16	50	4
UR512 0070106	0.7	0.1	1.2	6	45	4	UR512 01000520	1	0.05	1.5	20	50	4
UR512 0070108	0.7	0.1	1.2	8	45	4	UR512 0100103	1	0.1	1.5	3	50	4
UR512 0070110	0.7	0.1	1.2	10	45	4	UR512 0100104	1	0.1	1.5	4	50	4
UR512 0070202	0.7	0.2	1.2	2	45	4	UR512 0100106	1	0.1	1.5	6	50	4
UR512 0070204	0.7	0.2	1.2	4	45	4	UR512 0100108	1	0.1	1.5	8	50	4
UR512 0070206	0.7	0.2	1.2	6	45	4	UR512 0100110	1	0.1	1.5	10	50	4
UR512 0070208	0.7	0.2	1.2	8	45	4	UR512 0100112	1	0.1	1.5	12	50	4

Zamus Star

E-Star

U-Wing

Zamus Thunder

X-Star

S-Wing

A-Wing

Standard

Copper-Mate

Gra-Mate

▶ 적용 피삭재

○ : 적합 ◎ : 매우 적합

H		P			K	N			M	S
열처리강		탄소강	합금강	프리하드강	주철	동	흑연	알루미늄	스테인리스	내열합금
SKD61 ~HRc55	SKD11 HRc55~	~HB225	HB225 ~325	HRc30~50	~FCD500					
○		○	◎	◎	○					

UR512

2날 벡타입 래디우스 엔드밀

Endmill

품목코드	DC	RE	APMX	LU	OAL	DCONMS	품목코드	DC	RE	APMX	LU	OAL	DCONMS
	날경	Corner R	날장	유효장	전장	자루경		날경	Corner R	날장	유효장	전장	자루경
UR512 0100114	1	0.1	1.5	14	50	4	UR512 0120112	1.2	0.1	1.8	12	50	4
UR512 0100116	1	0.1	1.5	16	50	4	UR512 0120116	1.2	0.1	1.8	16	50	4
UR512 0100120	1	0.1	1.5	20	50	4	UR512 0120120	1.2	0.1	1.8	20	50	4
UR512 0100203	1	0.2	1.5	3	50	4	UR512 0120203	1.2	0.2	1.8	3	50	4
UR512 0100204	1	0.2	1.5	4	50	4	UR512 0120204	1.2	0.2	1.8	4	50	4
UR512 0100206	1	0.2	1.5	6	50	4	UR512 0120206	1.2	0.2	1.8	6	50	4
UR512 0100208	1	0.2	1.5	8	50	4	UR512 0120208	1.2	0.2	1.8	8	50	4
UR512 0100210	1	0.2	1.5	10	50	4	UR512 0120210	1.2	0.2	1.8	10	50	4
UR512 0100212	1	0.2	1.5	12	50	4	UR512 0120212	1.2	0.2	1.8	12	50	4
UR512 0100214	1	0.2	1.5	14	50	4	UR512 0120216	1.2	0.2	1.8	16	50	4
UR512 0100216	1	0.2	1.5	16	50	4	UR512 0120220	1.2	0.2	1.8	20	50	4
UR512 0100220	1	0.2	1.5	20	50	4	UR512 0120303	1.2	0.3	1.8	3	50	4
UR512 0100303	1	0.3	1.5	3	50	4	UR512 0120304	1.2	0.3	1.8	4	50	4
UR512 0100304	1	0.3	1.5	4	50	4	UR512 0120306	1.2	0.3	1.8	6	50	4
UR512 0100306	1	0.3	1.5	6	50	4	UR512 0120308	1.2	0.3	1.8	8	50	4
UR512 0100308	1	0.3	1.5	8	50	4	UR512 0120310	1.2	0.3	1.8	10	50	4
UR512 0100310	1	0.3	1.5	10	50	4	UR512 0120312	1.2	0.3	1.8	12	50	4
UR512 0100312	1	0.3	1.5	12	50	4	UR512 0120316	1.2	0.3	1.8	16	50	4
UR512 0100314	1	0.3	1.5	14	50	4	UR512 0120320	1.2	0.3	1.8	20	50	4
UR512 0100316	1	0.3	1.5	16	50	4	UR512 01500504	1.5	0.05	2.3	4	50	4
UR512 0100320	1	0.3	1.5	20	50	4	UR512 01500506	1.5	0.05	2.3	6	50	4
UR512 01200503	1.2	0.05	1.8	3	50	4	UR512 01500508	1.5	0.05	2.3	8	50	4
UR512 01200504	1.2	0.05	1.8	4	50	4	UR512 01500510	1.5	0.05	2.3	10	50	4
UR512 01200506	1.2	0.05	1.8	6	50	4	UR512 01500512	1.5	0.05	2.3	12	50	4
UR512 01200508	1.2	0.05	1.8	8	50	4	UR512 01500514	1.5	0.05	2.3	14	50	4
UR512 01200510	1.2	0.05	1.8	10	50	4	UR512 01500516	1.5	0.05	2.3	16	50	4
UR512 01200512	1.2	0.05	1.8	12	50	4	UR512 01500520	1.5	0.05	2.3	20	50	4
UR512 01200516	1.2	0.05	1.8	16	50	4	UR512 01500522	1.5	0.05	2.3	22	60	4
UR512 01200520	1.2	0.05	1.8	20	50	4	UR512 01500526	1.5	0.05	2.3	26	60	4
UR512 0120103	1.2	0.1	1.8	3	50	4	UR512 0150104	1.5	0.1	2.3	4	50	4
UR512 0120104	1.2	0.1	1.8	4	50	4	UR512 0150106	1.5	0.1	2.3	6	50	4
UR512 0120106	1.2	0.1	1.8	6	50	4	UR512 0150108	1.5	0.1	2.3	8	50	4
UR512 0120108	1.2	0.1	1.8	8	50	4	UR512 0150110	1.5	0.1	2.3	10	50	4
UR512 0120110	1.2	0.1	1.8	10	50	4	UR512 0150112	1.5	0.1	2.3	12	50	4

▶ 적용 피삭재

○ : 적합 ◎ : 매우 적합

H		P			K	N		M	S	
열처리강		탄소강	합금강	프리하든강	주철	동	흑연	알루미늄	스테인리스	내열합금
SKD61 ~HRc55	SKD11 HRc55~	~HB225	HB225 ~325	HRc30~50	~FCD500					
○		○	◎	◎	○					

UR512 2날 벡타입 래디우스 엔드밀

Endmill

품목코드	DC	RE	APMX	LU	OAL	DCONMS	품목코드	DC	RE	APMX	LU	OAL	DCONMS
	날경	Corner R	날장	유효장	전장	자루경		날경	Corner R	날장	유효장	전장	자루경
UR512 0150114	1.5	0.1	2.3	14	50	4	UR512 0150526	1.5	0.5	2.3	26	60	4
UR512 0150116	1.5	0.1	2.3	16	50	4	UR512 0200106	2	0.1	3	6	50	4
UR512 0150120	1.5	0.1	2.3	20	50	4	UR512 0200108	2	0.1	3	8	50	4
UR512 0150122	1.5	0.1	2.3	22	60	4	UR512 0200110	2	0.1	3	10	50	4
UR512 0150126	1.5	0.1	2.3	26	60	4	UR512 0200112	2	0.1	3	12	50	4
UR512 0150204	1.5	0.2	2.3	4	50	4	UR512 0200114	2	0.1	3	14	50	4
UR512 0150206	1.5	0.2	2.3	6	50	4	UR512 0200116	2	0.1	3	16	50	4
UR512 0150208	1.5	0.2	2.3	8	50	4	UR512 0200120	2	0.1	3	20	50	4
UR512 0150210	1.5	0.2	2.3	10	50	4	UR512 0200122	2	0.1	3	22	60	4
UR512 0150212	1.5	0.2	2.3	12	50	4	UR512 0200126	2	0.1	3	26	60	4
UR512 0150214	1.5	0.2	2.3	14	50	4	UR512 0200130	2	0.1	3	30	70	4
UR512 0150216	1.5	0.2	2.3	16	50	4	UR512 0200206	2	0.2	3	6	50	4
UR512 0150220	1.5	0.2	2.3	20	50	4	UR512 0200208	2	0.2	3	8	50	4
UR512 0150222	1.5	0.2	2.3	22	60	4	UR512 0200210	2	0.2	3	10	50	4
UR512 0150226	1.5	0.2	2.3	26	60	4	UR512 0200212	2	0.2	3	12	50	4
UR512 0150304	1.5	0.3	2.3	4	50	4	UR512 0200214	2	0.2	3	14	50	4
UR512 0150306	1.5	0.3	2.3	6	50	4	UR512 0200216	2	0.2	3	16	50	4
UR512 0150308	1.5	0.3	2.3	8	50	4	UR512 0200220	2	0.2	3	20	50	4
UR512 0150310	1.5	0.3	2.3	10	50	4	UR512 0200222	2	0.2	3	22	60	4
UR512 0150312	1.5	0.3	2.3	12	50	4	UR512 0200226	2	0.2	3	26	60	4
UR512 0150314	1.5	0.3	2.3	14	50	4	UR512 0200230	2	0.2	3	30	70	4
UR512 0150316	1.5	0.3	2.3	16	50	4	UR512 0200306	2	0.3	3	6	50	4
UR512 0150320	1.5	0.3	2.3	20	50	4	UR512 0200308	2	0.3	3	8	50	4
UR512 0150322	1.5	0.3	2.3	22	60	4	UR512 0200310	2	0.3	3	10	50	4
UR512 0150326	1.5	0.3	2.3	26	60	4	UR512 0200312	2	0.3	3	12	50	4
UR512 0150504	1.5	0.5	2.3	4	50	4	UR512 0200314	2	0.3	3	14	50	4
UR512 0150506	1.5	0.5	2.3	6	50	4	UR512 0200316	2	0.3	3	16	50	4
UR512 0150508	1.5	0.5	2.3	8	50	4	UR512 0200320	2	0.3	3	20	50	4
UR512 0150510	1.5	0.5	2.3	10	50	4	UR512 0200322	2	0.3	3	22	60	4
UR512 0150512	1.5	0.5	2.3	12	50	4	UR512 0200326	2	0.3	3	26	60	4
UR512 0150514	1.5	0.5	2.3	14	50	4	UR512 0200330	2	0.3	3	30	70	4
UR512 0150516	1.5	0.5	2.3	16	50	4	UR512 0200506	2	0.5	3	6	50	4
UR512 0150520	1.5	0.5	2.3	20	50	4	UR512 0200508	2	0.5	3	8	50	4
UR512 0150522	1.5	0.5	2.3	22	60	4	UR512 0200510	2	0.5	3	10	50	4

Zamus Star
E-Star
U-Wing
Zamus Thunder
X-Star
S-Wing
A-Wing
Standard
Copper-Mate
Gra-Mate

▶ 적용 피삭재

○ : 적합 ◎ : 매우 적합

H		P			K	N			M	S
열처리강		탄소강	합금강	프리하트강	주철	동	흑연	알루미늄	스테인리스	내열합금
SKD61 ~HRc55	SKD11 HRc55~	~HB225	HB225 ~325	HRc30~50	~FCD500					
○		○	◎	◎	○					

UR512

2날 벡타입 래디우스 엔드밀

Endmill

품목코드	DC	RE	APMX	LU	OAL	DCONMS	품목코드	DC	RE	APMX	LU	OAL	DCONMS
	날경	Corner R	날장	유효장	전장	자루경		날경	Corner R	날장	유효장	전장	자루경
UR512 0200512	2	0.5	3	12	50	4	UR512 0250514	2.5	0.5	4	14	50	4
UR512 0200514	2	0.5	3	14	50	4	UR512 0250516	2.5	0.5	4	16	50	4
UR512 0200516	2	0.5	3	16	50	4	UR512 0250520	2.5	0.5	4	20	50	4
UR512 0200520	2	0.5	3	20	50	4	UR512 0250526	2.5	0.5	4	26	60	4
UR512 0200522	2	0.5	3	22	60	4	UR512 0250530	2.5	0.5	4	30	70	4
UR512 0200526	2	0.5	3	26	60	4	UR512 0300108	3	0.1	4.5	8	50	6
UR512 0200530	2	0.5	3	30	70	4	UR512 0300110	3	0.1	4.5	10	50	6
UR512 0250108	2.5	0.1	4	8	50	4	UR512 0300112	3	0.1	4.5	12	50	6
UR512 0250110	2.5	0.1	4	10	50	4	UR512 0300114	3	0.1	4.5	14	60	6
UR512 0250112	2.5	0.1	4	12	50	4	UR512 0300116	3	0.1	4.5	16	60	6
UR512 0250114	2.5	0.1	4	14	50	4	UR512 0300120	3	0.1	4.5	20	60	6
UR512 0250116	2.5	0.1	4	16	50	4	UR512 0300126	3	0.1	4.5	26	65	6
UR512 0250120	2.5	0.1	4	20	50	4	UR512 0300130	3	0.1	4.5	30	70	6
UR512 0250126	2.5	0.1	4	26	60	4	UR512 0300135	3	0.1	4.5	35	70	6
UR512 0250130	2.5	0.1	4	30	70	4	UR512 0300140	3	0.1	4.5	40	80	6
UR512 0250208	2.5	0.2	4	8	50	4	UR512 0300208	3	0.2	4.5	8	50	6
UR512 0250210	2.5	0.2	4	10	50	4	UR512 0300210	3	0.2	4.5	10	50	6
UR512 0250212	2.5	0.2	4	12	50	4	UR512 0300212	3	0.2	4.5	12	50	6
UR512 0250214	2.5	0.2	4	14	50	4	UR512 0300214	3	0.2	4.5	14	60	6
UR512 0250216	2.5	0.2	4	16	50	4	UR512 0300216	3	0.2	4.5	16	60	6
UR512 0250220	2.5	0.2	4	20	50	4	UR512 0300220	3	0.2	4.5	20	60	6
UR512 0250226	2.5	0.2	4	26	60	4	UR512 0300226	3	0.2	4.5	26	65	6
UR512 0250230	2.5	0.2	4	30	70	4	UR512 0300230	3	0.2	4.5	30	70	6
UR512 0250308	2.5	0.3	4	8	50	4	UR512 0300235	3	0.2	4.5	35	70	6
UR512 0250310	2.5	0.3	4	10	50	4	UR512 0300240	3	0.2	4.5	40	80	6
UR512 0250312	2.5	0.3	4	12	50	4	UR512 0300308	3	0.3	4.5	8	50	6
UR512 0250314	2.5	0.3	4	14	50	4	UR512 0300310	3	0.3	4.5	10	50	6
UR512 0250316	2.5	0.3	4	16	50	4	UR512 0300312	3	0.3	4.5	12	50	6
UR512 0250320	2.5	0.3	4	20	50	4	UR512 0300314	3	0.3	4.5	14	60	6
UR512 0250326	2.5	0.3	4	26	60	4	UR512 0300316	3	0.3	4.5	16	60	6
UR512 0250330	2.5	0.3	4	30	70	4	UR512 0300320	3	0.3	4.5	20	60	6
UR512 0250508	2.5	0.5	4	8	50	4	UR512 0300326	3	0.3	4.5	26	65	6
UR512 0250510	2.5	0.5	4	10	50	4	UR512 0300330	3	0.3	4.5	30	70	6
UR512 0250512	2.5	0.5	4	12	50	4	UR512 0300335	3	0.3	4.5	35	70	6

▶ 적용 피삭재

○ : 적합 ◎ : 매우 적합

H		P			K	N		M	S	
열처리강		탄소강	합금강	프리하든강	주철	동	흑연	알루미늄	스테인리스	내열합금
SKD61 ~HRc55	SKD11 HRc55~	~HB225	HB225 ~325	HRc30~50	~FCD500					
○		○	◎	◎	○					

UR512 2날 벡타입 래디우스 엔드밀

Endmill

품목코드	DC	RE	APMX	LU	OAL	DCONMS	품목코드	DC	RE	APMX	LU	OAL	DCONMS
	날경	Corner R	날장	유효장	전장	자루경		날경	Corner R	날장	유효장	전장	자루경
UR512 0300340	3	0.3	4.5	40	80	6	UR512 0400214	4	0.2	6	14	60	6
UR512 0300508	3	0.5	4.5	8	50	6	UR512 0400216	4	0.2	6	16	60	6
UR512 0300510	3	0.5	4.5	10	50	6	UR512 0400220	4	0.2	6	20	60	6
UR512 0300512	3	0.5	4.5	12	50	6	UR512 0400226	4	0.2	6	26	65	6
UR512 0300514	3	0.5	4.5	14	60	6	UR512 0400230	4	0.2	6	30	65	6
UR512 0300516	3	0.5	4.5	16	60	6	UR512 0400235	4	0.2	6	35	70	6
UR512 0300520	3	0.5	4.5	20	60	6	UR512 0400240	4	0.2	6	40	80	6
UR512 0300526	3	0.5	4.5	26	65	6	UR512 0400245	4	0.2	6	45	90	6
UR512 0300530	3	0.5	4.5	30	70	6	UR512 0400250	4	0.2	6	50	100	6
UR512 0300535	3	0.5	4.5	35	70	6	UR512 0400310	4	0.3	6	10	50	6
UR512 0300540	3	0.5	4.5	40	80	6	UR512 0400312	4	0.3	6	12	50	6
UR512 0301008	3	1	4.5	8	50	6	UR512 0400314	4	0.3	6	14	60	6
UR512 0301010	3	1	4.5	10	50	6	UR512 0400316	4	0.3	6	16	60	6
UR512 0301012	3	1	4.5	12	50	6	UR512 0400320	4	0.3	6	20	60	6
UR512 0301014	3	1	4.5	14	60	6	UR512 0400326	4	0.3	6	26	65	6
UR512 0301016	3	1	4.5	16	60	6	UR512 0400330	4	0.3	6	30	65	6
UR512 0301020	3	1	4.5	20	60	6	UR512 0400335	4	0.3	6	35	70	6
UR512 0301026	3	1	4.5	26	65	6	UR512 0400340	4	0.3	6	40	80	6
UR512 0301030	3	1	4.5	30	70	6	UR512 0400345	4	0.3	6	45	90	6
UR512 0301035	3	1	4.5	35	70	6	UR512 0400350	4	0.3	6	50	100	6
UR512 0301040	3	1	4.5	40	80	6	UR512 0400510	4	0.5	6	10	50	6
UR512 0400110	4	0.1	6	10	50	6	UR512 0400512	4	0.5	6	12	50	6
UR512 0400112	4	0.1	6	12	50	6	UR512 0400514	4	0.5	6	14	60	6
UR512 0400114	4	0.1	6	14	60	6	UR512 0400516	4	0.5	6	16	60	6
UR512 0400116	4	0.1	6	16	60	6	UR512 0400520	4	0.5	6	20	60	6
UR512 0400120	4	0.1	6	20	60	6	UR512 0400526	4	0.5	6	26	65	6
UR512 0400126	4	0.1	6	26	65	6	UR512 0400530	4	0.5	6	30	65	6
UR512 0400130	4	0.1	6	30	65	6	UR512 0400535	4	0.5	6	35	70	6
UR512 0400135	4	0.1	6	35	70	6	UR512 0400540	4	0.5	6	40	80	6
UR512 0400140	4	0.1	6	40	80	6	UR512 0400545	4	0.5	6	45	90	6
UR512 0400145	4	0.1	6	45	90	6	UR512 0400550	4	0.5	6	50	100	6
UR512 0400150	4	0.1	6	50	100	6	UR512 0401010	4	1	6	10	50	6
UR512 0400210	4	0.2	6	10	50	6	UR512 0401012	4	1	6	12	50	6
UR512 0400212	4	0.2	6	12	50	6	UR512 0401014	4	1	6	14	60	6

Zamus Star
E-Star
U-Wing
Zamus Thunder
X-Star
S-Wing
A-Wing
Standard
Copper-Mate
Gra-Mate

▶ 적용 피삭재

○ : 적합 ◎ : 매우 적합

H		P			K	N			M	S
열처리강		탄소강	합금강	프리하든강	주철	동	흑연	알루미늄	스테인리스	내열합금
SKD61 ~HRC55	SKD11 HRC55~	~HB225	HB225 ~325	HRC30~50	~FCD500					
○		○	◎	◎	○					

UR512 2날 벡타입 래디우스 엔드밀

Endmill

품목코드	DC	RE	APMX	LU	OAL	DCONMS	품목코드	DC	RE	APMX	LU	OAL	DCONMS
	날경	Corner R	날장	유효장	전장	자루경		날경	Corner R	날장	유효장	전장	자루경
UR512 0401016	4	1	6	16	60	6	UR512 08010	8	1	12	25	70	8
UR512 0401020	4	1	6	20	60	6	UR512 08010100	8	1	20	35	100	8
UR512 0401026	4	1	6	26	65	6	UR512 08015	8	1.5	12	25	70	8
UR512 0401030	4	1	6	30	65	6	UR512 08020	8	2	12	25	70	8
UR512 0401035	4	1	6	35	70	6	UR512 10001	10	0.1	15	30	75	10
UR512 0401040	4	1	6	40	80	6	UR512 10002	10	0.2	15	30	75	10
UR512 0401045	4	1	6	45	90	6	UR512 10003	10	0.3	15	30	75	10
UR512 0401050	4	1	6	50	100	6	UR512 10003100	10	0.3	25	40	100	10
UR512 05001	5	0.1	8	15	60	6	UR512 10005	10	0.5	15	30	75	10
UR512 05002	5	0.2	8	15	60	6	UR512 10005100	10	0.5	25	40	100	10
UR512 05003	5	0.3	8	15	60	6	UR512 10010	10	1	15	30	75	10
UR512 05005	5	0.5	8	15	60	6	UR512 10010100	10	1	25	40	100	10
UR512 05010	5	1	8	15	60	6	UR512 10015	10	1.5	15	30	75	10
UR512 05015	5	1.5	8	15	60	6	UR512 10020	10	2	15	30	75	10
UR512 05020	5	2	8	15	60	6	UR512 12002	12	0.2	18	32	80	12
UR512 06001	6	0.1	9	20	60	6	UR512 12003	12	0.3	18	32	80	12
UR512 06002	6	0.2	9	20	60	6	UR512 12003110	12	0.3	30	45	110	12
UR512 06003	6	0.3	9	20	60	6	UR512 12005	12	0.5	18	32	80	12
UR512 0600390	6	0.3	15	30	90	6	UR512 12005110	12	0.5	30	45	110	12
UR512 06005	6	0.5	9	20	60	6	UR512 12010	12	1	18	32	80	12
UR512 0600590	6	0.5	15	30	90	6	UR512 12010110	12	1	30	45	110	12
UR512 06010	6	1	9	20	60	6	UR512 12015	12	1.5	18	32	80	12
UR512 0601090	6	1	15	30	90	6	UR512 12020	12	2	18	32	80	12
UR512 06015	6	1.5	9	20	60	6	UR512 16005	16	0.5	20	35	100	16
UR512 06020	6	2	9	20	60	6	UR512 16005150	16	0.5	35	50	150	16
UR512 08001	8	0.1	12	25	70	8	UR512 16010	16	1	20	35	100	16
UR512 08002	8	0.2	12	25	70	8	UR512 16010150	16	1	35	50	150	16
UR512 08003	8	0.3	12	25	70	8	UR512 20005	20	0.5	25	40	100	20
UR512 08003100	8	0.3	20	35	100	8	UR512 20005150	20	0.5	40	55	150	20
UR512 08005	8	0.5	12	25	70	8	UR512 20010	20	1	25	40	100	20
UR512 08005100	8	0.5	20	35	100	8	UR512 20010150	20	1	40	55	150	20

▶ 적용 피삭재

○ : 적합 ◎ : 매우 적합

H		P			K	N			M	S
열처리강		탄소강	합금강	프리하든강	주철	동	흑연	알루미늄	스테인리스	내열합금
SKD61 ~HRc55	SKD11 HRc55~	~HB225	HB225 ~325	Hrc30~50	~FCD500					
○		○	◎	◎	○					

UR542 2날 테이퍼 넥 래디우스 엔드밀

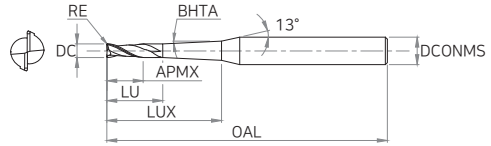

▶ 제품허용공차

날경(DC)		자루경
∅0.2 ~ ∅4	0 ~ -0.012	h5

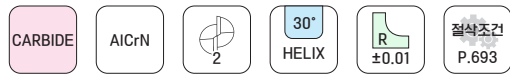
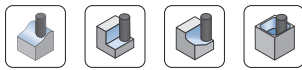

품목코드	DC	RE	BHTA	APMX	LU	LUX	OAL	DCONMS
	날경	Corner R	테이퍼각	날장	유효장	유효장	전장	자루경
UR542 0020050101	0.2	0.05	1	0.3	0.4	1	40	4
UR542 0020050102	0.2	0.05	1	0.3	0.4	2	40	4
UR542 0020050103	0.2	0.05	1	0.3	0.4	3	40	4
UR542 0020050201	0.2	0.05	2	0.3	0.4	1	40	4
UR542 0020050202	0.2	0.05	2	0.3	0.4	2	40	4
UR542 0020050203	0.2	0.05	2	0.3	0.4	3	40	4
UR542 0030050102	0.3	0.05	1	0.5	0.6	2	40	4
UR542 0030050103	0.3	0.05	1	0.5	0.6	3	40	4
UR542 0030050104	0.3	0.05	1	0.5	0.6	4	40	4
UR542 0030050105	0.3	0.05	1	0.5	0.6	5	40	4
UR542 0030050202	0.3	0.05	2	0.5	0.6	2	40	4
UR542 0030050203	0.3	0.05	2	0.5	0.6	3	40	4
UR542 0030050204	0.3	0.05	2	0.5	0.6	4	40	4
UR542 0030050205	0.3	0.05	2	0.5	0.6	5	40	4
UR542 0040050102	0.4	0.05	1	0.6	0.8	2	50	4
UR542 0040050103	0.4	0.05	1	0.6	0.8	3	50	4
UR542 0040050104	0.4	0.05	1	0.6	0.8	4	50	4
UR542 0040050105	0.4	0.05	1	0.6	0.8	5	50	4
UR542 0040050106	0.4	0.05	1	0.6	0.8	6	50	4
UR542 0040050202	0.4	0.05	2	0.6	0.8	2	50	4

▶ 적용 피삭재

○ : 적합 ◎ : 매우 적합

H		P			K	N			M	S
열처리강		탄소강	합금강	프리하든강	주철	동	흑연	알루미늄	스테인리스	내열합금
SKD61 ~HRc55	SKD11 HRc55~	~HB225	HB225 ~325	HRc30~50	~FCD500					
○		○	◎	◎	○					

UR542

2날 테이퍼 넥 래디우스 엔드밀

Endmill

품목코드	DC	RE	BHTA	APMX	LU	LUX	OAL	DCONMS
	날경	Corner R	테이퍼각	날장	유효장	유효장	전장	자루경
UR542 0040050203	0.4	0.05	2	0.6	0.8	3	50	4
UR542 0040050204	0.4	0.05	2	0.6	0.8	4	50	4
UR542 0040050205	0.4	0.05	2	0.6	0.8	5	50	4
UR542 0040050206	0.4	0.05	2	0.6	0.8	6	50	4
UR542 004010102	0.4	0.1	1	0.6	0.8	2	50	4
UR542 004010103	0.4	0.1	1	0.6	0.8	3	50	4
UR542 004010104	0.4	0.1	1	0.6	0.8	4	50	4
UR542 004010105	0.4	0.1	1	0.6	0.8	5	50	4
UR542 004010106	0.4	0.1	1	0.6	0.8	6	50	4
UR542 004010202	0.4	0.1	2	0.6	0.8	2	50	4
UR542 004010203	0.4	0.1	2	0.6	0.8	3	50	4
UR542 004010204	0.4	0.1	2	0.6	0.8	4	50	4
UR542 004010205	0.4	0.1	2	0.6	0.8	5	50	4
UR542 004010206	0.4	0.1	2	0.6	0.8	6	50	4
UR542 0050050104	0.5	0.05	1	0.7	1	4	50	4
UR542 0050050106	0.5	0.05	1	0.7	1	6	50	4
UR542 0050050108	0.5	0.05	1	0.7	1	8	50	4
UR542 0050050110	0.5	0.05	1	0.7	1	10	50	4
UR542 0050050204	0.5	0.05	2	0.7	1	4	50	4
UR542 0050050206	0.5	0.05	2	0.7	1	6	50	4
UR542 0050050208	0.5	0.05	2	0.7	1	8	50	4
UR542 0050050210	0.5	0.05	2	0.7	1	10	50	4
UR542 005010104	0.5	0.1	1	0.7	1	4	50	4
UR542 005010106	0.5	0.1	1	0.7	1	6	50	4
UR542 005010108	0.5	0.1	1	0.7	1	8	50	4
UR542 005010110	0.5	0.1	1	0.7	1	10	50	4
UR542 005010204	0.5	0.1	2	0.7	1	4	50	4
UR542 005010206	0.5	0.1	2	0.7	1	6	50	4
UR542 005010208	0.5	0.1	2	0.7	1	8	50	4
UR542 005010210	0.5	0.1	2	0.7	1	10	50	4
UR542 006010104	0.6	0.1	1	0.9	1.2	4	50	4
UR542 006010106	0.6	0.1	1	0.9	1.2	6	50	4
UR542 006010108	0.6	0.1	1	0.9	1.2	8	50	4
UR542 006010110	0.6	0.1	1	0.9	1.2	10	50	4

▶ 적용 피삭재

○ : 적합 ◎ : 매우 적합

H		P			K	N			M	S
열처리강		탄소강	합금강	프리하든강	주철	동	흑연	알루미늄	스테인리스	내열합금
SKD61 ~HRc55	SKD11 HRc55~	~HB225	HB225 ~325	HRc30~50	~FCD500					
○		○	◎	◎	○					

UR542

2날 테이퍼 넥 래디우스 엔드밀

Endmill

품목코드	DC	RE	BHTA	APMX	LU	LUX	OAL	DCONMS
	날경	Corner R	테이퍼각	날장	유효장	유효장	전장	자루경
UR542 006010108	0.6	0.1	1	0.9	1.2	8	50	4
UR542 006010110	0.6	0.1	1	0.9	1.2	10	50	4
UR542 006010112	0.6	0.1	1	0.9	1.2	12	50	4
UR542 006010204	0.6	0.1	2	0.9	1.2	4	50	4
UR542 006010206	0.6	0.1	2	0.9	1.2	6	50	4
UR542 006010208	0.6	0.1	2	0.9	1.2	8	50	4
UR542 006010210	0.6	0.1	2	0.9	1.2	10	50	4
UR542 006010212	0.6	0.1	2	0.9	1.2	12	50	4
UR542 006020104	0.6	0.2	1	0.9	1.2	4	50	4
UR542 006020106	0.6	0.2	1	0.9	1.2	6	50	4
UR542 006020108	0.6	0.2	1	0.9	1.2	8	50	4
UR542 006020110	0.6	0.2	1	0.9	1.2	10	50	4
UR542 006020112	0.6	0.2	1	0.9	1.2	12	50	4
UR542 006020204	0.6	0.2	2	0.9	1.2	4	50	4
UR542 006020206	0.6	0.2	2	0.9	1.2	6	50	4
UR542 006020208	0.6	0.2	2	0.9	1.2	8	50	4
UR542 006020210	0.6	0.2	2	0.9	1.2	10	50	4
UR542 006020212	0.6	0.2	2	0.9	1.2	12	50	4
UR542 008010104	0.8	0.1	1	1.2	1.6	4	50	4
UR542 008010106	0.8	0.1	1	1.2	1.6	6	50	4
UR542 008010108	0.8	0.1	1	1.2	1.6	8	50	4
UR542 008010110	0.8	0.1	1	1.2	1.6	10	50	4
UR542 008010112	0.8	0.1	1	1.2	1.6	12	50	4
UR542 008010116	0.8	0.1	1	1.2	1.6	16	50	4
UR542 008010204	0.8	0.1	2	1.2	1.6	4	50	4
UR542 008010206	0.8	0.1	2	1.2	1.6	6	50	4
UR542 008010208	0.8	0.1	2	1.2	1.6	8	50	4
UR542 008010210	0.8	0.1	2	1.2	1.6	10	50	4
UR542 008010212	0.8	0.1	2	1.2	1.6	12	50	4
UR542 008010216	0.8	0.1	2	1.2	1.6	16	50	4
UR542 008020104	0.8	0.2	1	1.2	1.6	4	50	4
UR542 008020106	0.8	0.2	1	1.2	1.6	6	50	4
UR542 008020108	0.8	0.2	1	1.2	1.6	8	50	4
UR542 008020110	0.8	0.2	1	1.2	1.6	10	50	4

Zamus Star

E-Star

U-Wing

Zamus Thunder

X-Star

S-Wing

A-Wing

Standard

Copper-Mate

Gra-Mate

▶ 적용 피삭재

○ : 적합 ◎ : 매우 적합

H		P			K	N			M	S
열처리강		탄소강	합금강	프리하든강	주철	동	흑연	알루미늄	스테인리스	내열합금
SKD61 ~HRc55	SKD11 HRc55~	~HB225	HB225 ~325	HRc30~50	~FCD500					
○		○	◎	◎	○					

UR542

2날 테이퍼 넥 래디우스 엔드밀

Endmill

품목코드	DC	RE	BHTA	APMX	LU	LUX	OAL	DCONMS
	날경	Corner R	테이퍼각	날장	유효장	유효장	전장	자루경
UR542 008020104	0.8	0.2	1	1.2	1.6	4	50	4
UR542 008020106	0.8	0.2	1	1.2	1.6	6	50	4
UR542 008020108	0.8	0.2	1	1.2	1.6	8	50	4
UR542 008020110	0.8	0.2	1	1.2	1.6	10	50	4
UR542 008020112	0.8	0.2	1	1.2	1.6	12	50	4
UR542 008020116	0.8	0.2	1	1.2	1.6	16	50	4
UR542 008020204	0.8	0.2	2	1.2	1.6	4	50	4
UR542 008020206	0.8	0.2	2	1.2	1.6	6	50	4
UR542 008020208	0.8	0.2	2	1.2	1.6	8	50	4
UR542 008020210	0.8	0.2	2	1.2	1.6	10	50	4
UR542 008020212	0.8	0.2	2	1.2	1.6	12	50	4
UR542 008020216	0.8	0.2	2	1.2	1.6	16	50	4
UR542 010010106	1	0.1	1	1.5	2.5	6	50	4
UR542 010010108	1	0.1	1	1.5	2.5	8	50	4
UR542 010010110	1	0.1	1	1.5	2.5	10	50	4
UR542 010010112	1	0.1	1	1.5	2.5	12	50	4
UR542 010010116	1	0.1	1	1.5	2.5	16	50	4
UR542 010010120	1	0.1	1	1.5	2.5	20	50	4
UR542 010010125	1	0.1	1	1.5	2.5	25	60	4
UR542 010010130	1	0.1	1	1.5	2.5	30	70	4
UR542 010010140	1	0.1	1	1.5	2.5	40	80	4
UR542 010010150	1	0.1	1	1.5	2.5	50	90	6
UR542 010010206	1	0.1	2	1.5	2.5	6	50	4
UR542 010010208	1	0.1	2	1.5	2.5	8	50	4
UR542 010010210	1	0.1	2	1.5	2.5	10	50	4
UR542 010010212	1	0.1	2	1.5	2.5	12	50	4
UR542 010010216	1	0.1	2	1.5	2.5	16	50	4
UR542 010010220	1	0.1	2	1.5	2.5	20	50	4
UR542 010010225	1	0.1	2	1.5	2.5	25	60	4
UR542 010010230	1	0.1	2	1.5	2.5	30	70	4
UR542 010010240	1	0.1	2	1.5	2.5	40	80	4
UR542 010010250	1	0.1	2	1.5	2.5	50	90	6
UR542 010020106	1	0.2	1	1.5	2.5	6	50	4
UR542 010020108	1	0.2	1	1.5	2.5	8	50	4

▶ 적용 피삭재

○ : 적합 ◎ : 매우 적합

H		P			K	N			M	S
열처리강		탄소강	합금강	프리하든강	주철	동	흑연	알루미늄	스테인리스	내열합금
SKD61 ~HRc55	SKD11 HRc55~	~HB225	HB225 ~325	HRc30~50	~FCD500					
○		○	◎	◎	○					

UR542

2날 테이퍼 넥 래디우스 엔드밀

Endmill

품목코드	DC	RE	BHTA	APMX	LU	LUX	OAL	DCONMS
	날경	Corner R	테이퍼각	날장	유효장	유효장	전장	자루경
UR542 010020110	1	0.2	1	1.5	2.5	10	50	4
UR542 010020112	1	0.2	1	1.5	2.5	12	50	4
UR542 010020116	1	0.2	1	1.5	2.5	16	50	4
UR542 010020120	1	0.2	1	1.5	2.5	20	50	4
UR542 010020125	1	0.2	1	1.5	2.5	25	60	4
UR542 010020130	1	0.2	1	1.5	2.5	30	70	4
UR542 010020140	1	0.2	1	1.5	2.5	40	80	4
UR542 010020150	1	0.2	1	1.5	2.5	50	90	6
UR542 010020206	1	0.2	2	1.5	2.5	6	50	4
UR542 010020208	1	0.2	2	1.5	2.5	8	50	4
UR542 010020210	1	0.2	2	1.5	2.5	10	50	4
UR542 010020212	1	0.2	2	1.5	2.5	12	50	4
UR542 010020216	1	0.2	2	1.5	2.5	16	50	4
UR542 010020220	1	0.2	2	1.5	2.5	20	50	4
UR542 010020225	1	0.2	2	1.5	2.5	25	60	4
UR542 010020230	1	0.2	2	1.5	2.5	30	70	4
UR542 010020240	1	0.2	2	1.5	2.5	40	80	4
UR542 010020250	1	0.2	2	1.5	2.5	50	90	6
UR542 012010108	1.2	0.1	1	1.8	3	8	50	4
UR542 012010112	1.2	0.1	1	1.8	3	12	50	4
UR542 012010116	1.2	0.1	1	1.8	3	16	50	4
UR542 012010120	1.2	0.1	1	1.8	3	20	50	4
UR542 012010125	1.2	0.1	1	1.8	3	25	60	4
UR542 012010130	1.2	0.1	1	1.8	3	30	70	4
UR542 012010208	1.2	0.1	2	1.8	3	8	50	4
UR542 012010212	1.2	0.1	2	1.8	3	12	50	4
UR542 012010216	1.2	0.1	2	1.8	3	16	50	4
UR542 012010220	1.2	0.1	2	1.8	3	20	50	4
UR542 012010225	1.2	0.1	2	1.8	3	25	60	4
UR542 012010230	1.2	0.1	2	1.8	3	30	70	4
UR542 012020108	1.2	0.2	1	1.8	3	8	50	4
UR542 012020112	1.2	0.2	1	1.8	3	12	50	4
UR542 012020116	1.2	0.2	1	1.8	3	16	50	4
UR542 012020120	1.2	0.2	1	1.8	3	20	50	4

Zamus Star

E-Star

U-Wing

Zamus Thunder

X-Star

S-Wing

A-Wing

Standard

Copper-Mate

Gra-Mate

▶ 적용 피삭재

○ : 적합 ◎ : 매우 적합

H		P			K	N			M	S
열처리강		탄소강	합금강	프리하든강	주철	동	흑연	알루미늄	스테인리스	내열합금
SKD61 ~HRc55	SKD11 HRc55~	~HB225	HB225 ~325	HRc30~50	~FCD500					
○		○	◎	◎	○					

UR542

2날 테이퍼 넥 래디우스 엔드밀

Endmill

품목코드	DC	RE	BHTA	APMX	LU	LUX	OAL	DCONMS
	날경	Corner R	테이퍼각	날장	유효장	유효장	전장	자루경
UR542 012020125	1.2	0.2	1	1.8	3	25	60	4
UR542 012020130	1.2	0.2	1	1.8	3	30	70	4
UR542 012020208	1.2	0.2	2	1.8	3	8	50	4
UR542 012020212	1.2	0.2	2	1.8	3	12	50	4
UR542 012020216	1.2	0.2	2	1.8	3	16	50	4
UR542 012020220	1.2	0.2	2	1.8	3	20	50	4
UR542 012020225	1.2	0.2	2	1.8	3	25	60	4
UR542 012020230	1.2	0.2	2	1.8	3	30	70	4
UR542 015010108	1.5	0.1	1	2.3	3	8	50	4
UR542 015010110	1.5	0.1	1	2.3	3	10	50	4
UR542 015010112	1.5	0.1	1	2.3	3	12	50	4
UR542 015010116	1.5	0.1	1	2.3	3	16	50	4
UR542 015010120	1.5	0.1	1	2.3	3	20	50	4
UR542 015010125	1.5	0.1	1	2.3	3	25	60	4
UR542 015010130	1.5	0.1	1	2.3	3	30	70	4
UR542 015010140	1.5	0.1	1	2.3	3	40	80	4
UR542 015010150	1.5	0.1	1	2.3	3	50	90	4
UR542 015010208	1.5	0.1	2	2.3	3	8	50	4
UR542 015010210	1.5	0.1	2	2.3	3	10	50	4
UR542 015010212	1.5	0.1	2	2.3	3	12	50	4
UR542 015010216	1.5	0.1	2	2.3	3	16	50	4
UR542 015010220	1.5	0.1	2	2.3	3	20	50	4
UR542 015010225	1.5	0.1	2	2.3	3	25	60	4
UR542 015010230	1.5	0.1	2	2.3	3	30	70	4
UR542 015010240	1.5	0.1	2	2.3	3	40	80	6
UR542 015010250	1.5	0.1	2	2.3	3	50	90	6
UR542 015020108	1.5	0.2	1	2.3	3	8	50	4
UR542 015020110	1.5	0.2	1	2.3	3	10	50	4
UR542 015020112	1.5	0.2	1	2.3	3	12	50	4
UR542 015020116	1.5	0.2	1	2.3	3	16	50	4
UR542 015020120	1.5	0.2	1	2.3	3	20	50	4
UR542 015020125	1.5	0.2	1	2.3	3	25	60	4
UR542 015020130	1.5	0.2	1	2.3	3	30	70	4
UR542 015020140	1.5	0.2	1	2.3	3	40	80	4

▶ 적용 피삭재

○ : 적합 ◎ : 매우 적합

H		P			K	N			M	S
열처리강		탄소강	합금강	프리하든강	주철	동	흑연	알루미늄	스테인리스	내열합금
SKD61 ~HRc55	SKD11 HRc55~	~HB225	HB225 ~325	HRc30~50	~FCD500					
○		○	◎	◎	○					

UR542

2날 테이퍼 넥 래디우스 엔드밀

Endmill

품목코드	DC	RE	BHTA	APMX	LU	LUX	OAL	DCONMS
	날경	Corner R	테이퍼각	날장	유효장	유효장	전장	자루경
UR542 015020150	1.5	0.2	1	2.3	3	50	90	4
UR542 015020208	1.5	0.2	2	2.3	3	8	50	4
UR542 015020210	1.5	0.2	2	2.3	3	10	50	4
UR542 015020212	1.5	0.2	2	2.3	3	12	50	4
UR542 015020216	1.5	0.2	2	2.3	3	16	50	4
UR542 015020220	1.5	0.2	2	2.3	3	20	50	4
UR542 015020225	1.5	0.2	2	2.3	3	25	60	4
UR542 015020230	1.5	0.2	2	2.3	3	30	70	4
UR542 015020240	1.5	0.2	2	2.3	3	40	80	6
UR542 015020250	1.5	0.2	2	2.3	3	50	90	6
UR542 015030108	1.5	0.3	1	2.3	3	8	50	4
UR542 015030110	1.5	0.3	1	2.3	3	10	50	4
UR542 015030112	1.5	0.3	1	2.3	3	12	50	4
UR542 015030116	1.5	0.3	1	2.3	3	16	50	4
UR542 015030120	1.5	0.3	1	2.3	3	20	50	4
UR542 015030125	1.5	0.3	1	2.3	3	25	60	4
UR542 015030130	1.5	0.3	1	2.3	3	30	70	4
UR542 015030140	1.5	0.3	1	2.3	3	40	80	4
UR542 015030150	1.5	0.3	1	2.3	3	50	90	4
UR542 015030208	1.5	0.3	2	2.3	3	8	50	4
UR542 015030210	1.5	0.3	2	2.3	3	10	50	4
UR542 015030212	1.5	0.3	2	2.3	3	12	50	4
UR542 015030216	1.5	0.3	2	2.3	3	16	50	4
UR542 015030220	1.5	0.3	2	2.3	3	20	50	4
UR542 015030225	1.5	0.3	2	2.3	3	25	60	4
UR542 015030230	1.5	0.3	2	2.3	3	30	70	4
UR542 015030240	1.5	0.3	2	2.3	3	40	80	6
UR542 015030250	1.5	0.3	2	2.3	3	50	90	6
UR542 020010110	2	0.1	1	2	5	10	50	4
UR542 020010112	2	0.1	1	2	5	12	50	4
UR542 020010116	2	0.1	1	2	5	16	50	4
UR542 020010120	2	0.1	1	2	5	20	50	4
UR542 020010125	2	0.1	1	2	5	25	60	4
UR542 020010130	2	0.1	1	2	5	30	70	4

Zamus Star

E-Star

U-Wing

Zamus Thunder

X-Star

S-Wing

A-Wing

Standard

Copper-Mate

Gra-Mate

▶ 적용 피삭재

○ : 적합 ◎ : 매우 적합

H		P			K	N			M	S
열처리강		탄소강	합금강	프리하든강	주철	동	흑연	알루미늄	스테인리스	내열합금
SKD61 ~HRc55	SKD11 HRc55~	~HB225	HB225 ~325	HRc30~50	~FCD500					
○		○	◎	◎	○					

UR542

2날 테이퍼 넥 래디우스 엔드밀

Endmill

품목코드	DC	RE	BHTA	APMX	LU	LUX	OAL	DCONMS
	날경	Corner R	테이퍼각	날장	유효장	유효장	전장	자루경
UR542 020010140	2	0.1	1	2	5	40	80	6
UR542 020010150	2	0.1	1	2	5	50	100	6
UR542 020010160	2	0.1	1	2	5	60	100	6
UR542 020010180	2	0.1	1	2	5	80	140	6
UR542 020010210	2	0.1	2	2	5	10	50	4
UR542 020010212	2	0.1	2	2	5	12	50	4
UR542 020010216	2	0.1	2	2	5	16	50	4
UR542 020010220	2	0.1	2	2	5	20	50	4
UR542 020010225	2	0.1	2	2	5	25	60	4
UR542 020010230	2	0.1	2	2	5	30	70	4
UR542 020010240	2	0.1	2	2	5	40	80	6
UR542 020010250	2	0.1	2	2	5	50	100	6
UR542 020010260	2	0.1	2	2	5	60	100	6
UR542 020010280	2	0.1	2	2	5	80	140	8
UR542 020020110	2	0.2	1	2	5	10	50	4
UR542 020020112	2	0.2	1	2	5	12	50	4
UR542 020020116	2	0.2	1	2	5	16	50	4
UR542 020020120	2	0.2	1	2	5	20	50	4
UR542 020020125	2	0.2	1	2	5	25	60	4
UR542 020020130	2	0.2	1	2	5	30	70	4
UR542 020020140	2	0.2	1	2	5	40	80	6
UR542 020020150	2	0.2	1	2	5	50	100	6
UR542 020020160	2	0.2	1	2	5	60	100	6
UR542 020020180	2	0.2	1	2	5	80	140	6
UR542 020020210	2	0.2	2	2	5	10	50	4
UR542 020020212	2	0.2	2	2	5	12	50	4
UR542 020020216	2	0.2	2	2	5	16	50	4
UR542 020020220	2	0.2	2	2	5	20	50	4
UR542 020020225	2	0.2	2	2	5	25	60	4
UR542 020020230	2	0.2	2	2	5	30	70	4
UR542 020020240	2	0.2	2	2	5	40	80	6
UR542 020020250	2	0.2	2	2	5	50	100	6
UR542 020020260	2	0.2	2	2	5	60	100	6
UR542 020020280	2	0.2	2	2	5	80	140	8

▶ 적용 피삭재

○ : 적합 ◎ : 매우 적합

H		P			K	N			M	S
열처리강		탄소강	합금강	프리하든강	주철	동	흑연	알루미늄	스테인리스	내열합금
SKD61 ~HRc55	SKD11 HRc55~	~HB225	HB225 ~325	HRc30~50	~FCD500					
○		○	◎	◎	○					

UR542

2날 테이퍼 넥 래디우스 엔드밀

Endmill

품목코드	DC	RE	BHTA	APMX	LU	LUX	OAL	DCONMS
	날경	Corner R	테이퍼각	날장	유효장	유효장	전장	자루경
UR542 020030110	2	0.3	1	2	5	10	50	4
UR542 020030112	2	0.3	1	2	5	12	50	4
UR542 020030116	2	0.3	1	2	5	16	50	4
UR542 020030120	2	0.3	1	2	5	20	50	4
UR542 020030125	2	0.3	1	2	5	25	60	4
UR542 020030130	2	0.3	1	2	5	30	70	4
UR542 020030140	2	0.3	1	2	5	40	80	6
UR542 020030150	2	0.3	1	2	5	50	100	6
UR542 020030160	2	0.3	1	2	5	60	100	6
UR542 020030180	2	0.3	1	2	5	80	140	6
UR542 020030210	2	0.3	2	2	5	10	50	4
UR542 020030212	2	0.3	2	2	5	12	50	4
UR542 020030216	2	0.3	2	2	5	16	50	4
UR542 020030220	2	0.3	2	2	5	20	50	4
UR542 020030225	2	0.3	2	2	5	25	60	4
UR542 020030230	2	0.3	2	2	5	30	70	4
UR542 020030240	2	0.3	2	2	5	40	80	6
UR542 020030250	2	0.3	2	2	5	50	100	6
UR542 020030260	2	0.3	2	2	5	60	100	6
UR542 020030280	2	0.3	2	2	5	80	140	8
UR542 020050110	2	0.5	1	2	5	10	50	4
UR542 020050112	2	0.5	1	2	5	12	50	4
UR542 020050116	2	0.5	1	2	5	16	50	4
UR542 020050120	2	0.5	1	2	5	20	50	4
UR542 020050125	2	0.5	1	2	5	25	60	4
UR542 020050130	2	0.5	1	2	5	30	70	4
UR542 020050140	2	0.5	1	2	5	40	80	6
UR542 020050150	2	0.5	1	2	5	50	100	6
UR542 020050160	2	0.5	1	2	5	60	100	6
UR542 020050180	2	0.5	1	2	5	80	140	6
UR542 020050210	2	0.5	2	2	5	10	50	4
UR542 020050212	2	0.5	2	2	5	12	50	4
UR542 020050216	2	0.5	2	2	5	16	50	4
UR542 020050220	2	0.5	2	2	5	20	50	4

Zamus Star

E-Star

U-Wing

Zamus Thunder

X-Star

S-Wing

A-Wing

Standard

Copper-Mate

Gra-Mate

▶ 적용 피삭재

○ : 적합 ◎ : 매우 적합

H		P			K	N			M	S
열처리강		탄소강	합금강	프리하든강	주철	동	흑연	알루미늄	스테인리스	내열합금
SKD61 ~HRc55	SKD11 HRc55~	~HB225	HB225 ~325	HRc30~50	~FCD500					
○		○	◎	◎	○					

UR542

2날 테이퍼 넥 래디우스 엔드밀

Endmill

품목코드	DC	RE	BHTA	APMX	LU	LUX	OAL	DCONMS
	날경	Corner R	테이퍼각	날장	유효장	유효장	전장	자루경
UR542 020050225	2	0.5	2	2	5	25	60	4
UR542 020050230	2	0.5	2	2	5	30	70	4
UR542 020050240	2	0.5	2	2	5	40	80	6
UR542 020050250	2	0.5	2	2	5	50	100	6
UR542 020050260	2	0.5	2	2	5	60	100	6
UR542 020050280	2	0.5	2	2	5	80	140	8
UR542 030020116	3	0.2	1	4.5	6	16	60	6
UR542 030020120	3	0.2	1	4.5	6	20	65	6
UR542 030020130	3	0.2	1	4.5	6	30	70	6
UR542 030020140	3	0.2	1	4.5	6	40	80	6
UR542 030020150	3	0.2	1	4.5	6	50	90	6
UR542 030020160	3	0.2	1	4.5	6	60	100	6
UR542 030020216	3	0.2	2	4.5	6	16	60	6
UR542 030020220	3	0.2	2	4.5	6	20	65	6
UR542 030020230	3	0.2	2	4.5	6	30	70	6
UR542 030020240	3	0.2	2	4.5	6	40	80	6
UR542 030020250	3	0.2	2	4.5	6	50	90	8
UR542 030020260	3	0.2	2	4.5	6	60	100	8
UR542 030020270	3	0.2	2	4.5	6	70	120	8
UR542 030030116	3	0.3	1	4.5	6	16	60	6
UR542 030030120	3	0.3	1	4.5	6	20	65	6
UR542 030030130	3	0.3	1	4.5	6	30	70	6
UR542 030030140	3	0.3	1	4.5	6	40	80	6
UR542 030030150	3	0.3	1	4.5	6	50	90	6
UR542 030030160	3	0.3	1	4.5	6	60	100	6
UR542 030030216	3	0.3	2	4.5	6	16	60	6
UR542 030030220	3	0.3	2	4.5	6	20	65	6
UR542 030030230	3	0.3	2	4.5	6	30	70	6
UR542 030030240	3	0.3	2	4.5	6	40	80	6
UR542 030030250	3	0.3	2	4.5	6	50	90	8
UR542 030030260	3	0.3	2	4.5	6	60	100	8
UR542 030030270	3	0.3	2	4.5	6	70	120	8
UR542 030050116	3	0.5	1	4.5	6	16	60	6
UR542 030050120	3	0.5	1	4.5	6	20	65	6

▶ 적용 피삭재

○ : 적합 ◎ : 매우 적합

H		P			K	N			M	S
열처리강		탄소강	합금강	프리하든강	주철	동	흑연	알루미늄	스테인리스	내열합금
SKD61 ~HRc55	SKD11 HRc55~	~HB225	HB225 ~325	HRc30~50	~FCD500					
○		○	◎	◎	○					

UR542

2날 테이퍼 넥 래디우스 엔드밀

Endmill

품목코드	DC	RE	BHTA	APMX	LU	LUX	OAL	DCONMS
	날경	Corner R	테이퍼각	날장	유효장	유효장	전장	자루경
UR542 030050130	3	0.5	1	4.5	6	30	70	6
UR542 030050140	3	0.5	1	4.5	6	40	80	6
UR542 030050150	3	0.5	1	4.5	6	50	90	6
UR542 030050160	3	0.5	1	4.5	6	60	100	6
UR542 030050216	3	0.5	2	4.5	6	16	60	6
UR542 030050220	3	0.5	2	4.5	6	20	65	6
UR542 030050230	3	0.5	2	4.5	6	30	70	6
UR542 030050240	3	0.5	2	4.5	6	40	80	6
UR542 030050250	3	0.5	2	4.5	6	50	90	8
UR542 030050260	3	0.5	2	4.5	6	60	100	8
UR542 030050270	3	0.5	2	4.5	6	70	120	8
UR542 040020140	4	0.2	1	6	8	40	90	6
UR542 040020150	4	0.2	1	6	8	50	100	6
UR542 040020160	4	0.2	1	6	8	60	110	6
UR542 040020170	4	0.2	1	6	8	70	120	8
UR542 040020240	4	0.2	2	6	8	40	90	8
UR542 040020250	4	0.2	2	6	8	50	100	8
UR542 040020260	4	0.2	2	6	8	60	110	8
UR542 040020270	4	0.2	2	6	8	70	120	10
UR542 040030140	4	0.3	1	6	8	40	90	6
UR542 040030150	4	0.3	1	6	8	50	100	6
UR542 040030160	4	0.3	1	6	8	60	110	6
UR542 040030170	4	0.3	1	6	8	70	120	8
UR542 040030240	4	0.3	2	6	8	40	90	8
UR542 040030250	4	0.3	2	6	8	50	100	8
UR542 040030260	4	0.3	2	6	8	60	110	8
UR542 040030270	4	0.3	2	6	8	70	120	10
UR542 040050140	4	0.5	1	6	8	40	90	6
UR542 040050150	4	0.5	1	6	8	50	100	6
UR542 040050160	4	0.5	1	6	8	60	110	6
UR542 040050170	4	0.5	1	6	8	70	120	8
UR542 040050240	4	0.5	2	6	8	40	90	8
UR542 040050250	4	0.5	2	6	8	50	100	8
UR542 040050260	4	0.5	2	6	8	60	110	8
UR542 040050270	4	0.5	2	6	8	70	120	10

Zamus Star

E-Star

U-Wing

Zamus Thunder

X-Star

S-Wing

A-Wing

Standard

Copper-Mate

Gra-Mate

▶ 적용 피삭재

○ : 적합 ◎ : 매우 적합

H		P			K	N			M	S
열처리강		탄소강	합금강	프리하든강	주철	동	흑연	알루미늄	스테인리스	내열합금
SKD61 ~HRc55	SKD11 HRc55~	~HB225	HB225 ~325	HRc30~50	~FCD500					
○		○	◎	◎	○					

UR544

4날 테이퍼 넥 래디우스 엔드밀

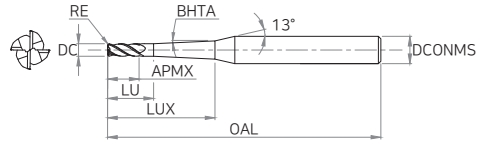

▶ 제품허용공차

날경(DC)		자루경
Ø1 ~ Ø4	0 ~ -0.012	h5

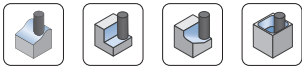

품목코드	DC	RE	BHTA	APMX	LU	LUX	OAL	DCONMS
	날경	Corner R	테이퍼각	날장	유효장	유효장	전장	자루경
UR544 010010106	1	0.1	1	1.5	2.5	6	50	4
UR544 010010108	1	0.1	1	1.5	2.5	8	50	4
UR544 010010110	1	0.1	1	1.5	2.5	10	50	4
UR544 010010112	1	0.1	1	1.5	2.5	12	50	4
UR544 010010116	1	0.1	1	1.5	2.5	16	50	4
UR544 010010120	1	0.1	1	1.5	2.5	20	50	4
UR544 010010125	1	0.1	1	1.5	2.5	25	60	4
UR544 010010130	1	0.1	1	1.5	2.5	30	70	4
UR544 010010140	1	0.1	1	1.5	2.5	40	80	4
UR544 010010150	1	0.1	1	1.5	2.5	50	90	4
UR544 010010206	1	0.1	2	1.5	2.5	6	50	4
UR544 010010208	1	0.1	2	1.5	2.5	8	50	4
UR544 010010210	1	0.1	2	1.5	2.5	10	50	4
UR544 010010212	1	0.1	2	1.5	2.5	12	50	4
UR544 010010216	1	0.1	2	1.5	2.5	16	50	4
UR544 010010220	1	0.1	2	1.5	2.5	20	50	4
UR544 010010225	1	0.1	2	1.5	2.5	25	60	4
UR544 010010230	1	0.1	2	1.5	2.5	30	70	4
UR544 010010240	1	0.1	2	1.5	2.5	40	80	4
UR544 010010250	1	0.1	2	1.5	2.5	50	90	6

▶ 적용 피삭재

○ : 적합 ◎ : 매우 적합

H		P			K	N		M	S	
열처리강		탄소강	합금강	프리하든강	주철	동	흑연	알루미늄	스테인리스	내열합금
SKD61 ~HRc55	SKD11 HRc55~	~HB225	HB225 ~325	HRc30~50	~FCD500					
○		○	◎	◎	○					

UR544 4날 테이퍼 넥 라디우스 엔드밀

Endmill

품목코드	DC	RE	BHTA	APMX	LU	LUX	OAL	DCONMS
	날경	Corner R	테이퍼각	날장	유효장	유효장	전장	자루경
UR544 010020106	1	0.2	1	1.5	2.5	6	50	4
UR544 010020108	1	0.2	1	1.5	2.5	8	50	4
UR544 010020110	1	0.2	1	1.5	2.5	10	50	4
UR544 010020112	1	0.2	1	1.5	2.5	12	50	4
UR544 010020116	1	0.2	1	1.5	2.5	16	50	4
UR544 010020120	1	0.2	1	1.5	2.5	20	50	4
UR544 010020125	1	0.2	1	1.5	2.5	25	60	4
UR544 010020130	1	0.2	1	1.5	2.5	30	70	4
UR544 010020140	1	0.2	1	1.5	2.5	40	80	4
UR544 010020150	1	0.2	1	1.5	2.5	50	90	4
UR544 010020206	1	0.2	2	1.5	2.5	6	50	4
UR544 010020208	1	0.2	2	1.5	2.5	8	50	4
UR544 010020210	1	0.2	2	1.5	2.5	10	50	4
UR544 010020212	1	0.2	2	1.5	2.5	12	50	4
UR544 010020216	1	0.2	2	1.5	2.5	16	50	4
UR544 010020220	1	0.2	2	1.5	2.5	20	50	4
UR544 010020225	1	0.2	2	1.5	2.5	25	60	4
UR544 010020230	1	0.2	2	1.5	2.5	30	70	4
UR544 010020240	1	0.2	2	1.5	2.5	40	80	4
UR544 010020250	1	0.2	2	1.5	2.5	50	90	6
UR544 012010108	1.2	0.1	1	1.8	3	8	50	4
UR544 012010112	1.2	0.1	1	1.8	3	12	50	4
UR544 012010116	1.2	0.1	1	1.8	3	16	50	4
UR544 012010120	1.2	0.1	1	1.8	3	20	50	4
UR544 012010125	1.2	0.1	1	1.8	3	25	60	4
UR544 012010130	1.2	0.1	1	1.8	3	30	70	4
UR544 012010208	1.2	0.1	2	1.8	3	8	50	4
UR544 012010212	1.2	0.1	2	1.8	3	12	50	4
UR544 012010216	1.2	0.1	2	1.8	3	16	50	4
UR544 012010220	1.2	0.1	2	1.8	3	20	50	4
UR544 012010225	1.2	0.1	2	1.8	3	25	60	4
UR544 012010230	1.2	0.1	2	1.8	3	30	70	4
UR544 012020108	1.2	0.2	1	1.8	3	8	50	4
UR544 012020112	1.2	0.2	1	1.8	3	12	50	4

Zamus Star
E-Star
U-Wing
Zamus Thunder
X-Star
S-Wing
A-Wing
Standard
Copper-Mate
Gra-Mate

▶ 적용 피삭재

○ : 적합 ◎ : 매우 적합

H		P			K	N			M	S
열처리강		탄소강	합금강	프리하든강	주철	동	흑연	알루미늄	스테인리스	내열합금
SKD61 ~HRc55	SKD11 HRc55~	~HB225	HB225 ~325	HRc30~50	~FCD500					
○		○	◎	◎	○					

UR544

4날 테이퍼 넥 래디우스 엔드밀

Endmill

품목코드	DC	RE	BHTA	APMX	LU	LUX	OAL	DCONMS
	날경	Corner R	테이퍼각	날장	유효장	유효장	전장	자루경
UR544 012020116	1.2	0.2	1	1.8	3	16	50	4
UR544 012020120	1.2	0.2	1	1.8	3	20	50	4
UR544 012020125	1.2	0.2	1	1.8	3	25	60	4
UR544 012020130	1.2	0.2	1	1.8	3	30	70	4
UR544 012020208	1.2	0.2	2	1.8	3	8	50	4
UR544 012020212	1.2	0.2	2	1.8	3	12	50	4
UR544 012020216	1.2	0.2	2	1.8	3	16	50	4
UR544 012020220	1.2	0.2	2	1.8	3	20	50	4
UR544 012020225	1.2	0.2	2	1.8	3	25	60	4
UR544 012020230	1.2	0.2	2	1.8	3	30	70	4
UR544 015010108	1.5	0.1	1	2.3	3	8	50	4
UR544 015010110	1.5	0.1	1	2.3	3	10	50	4
UR544 015010112	1.5	0.1	1	2.3	3	12	50	4
UR544 015010116	1.5	0.1	1	2.3	3	16	50	4
UR544 015010120	1.5	0.1	1	2.3	3	20	50	4
UR544 015010125	1.5	0.1	1	2.3	3	25	60	4
UR544 015010130	1.5	0.1	1	2.3	3	30	70	4
UR544 015010140	1.5	0.1	1	2.3	3	40	80	4
UR544 015010150	1.5	0.1	1	2.3	3	50	90	4
UR544 015010208	1.5	0.1	2	2.3	3	8	50	4
UR544 015010210	1.5	0.1	2	2.3	3	10	50	4
UR544 015010212	1.5	0.1	2	2.3	3	12	50	4
UR544 015010216	1.5	0.1	2	2.3	3	16	50	4
UR544 015010220	1.5	0.1	2	2.3	3	20	50	4
UR544 015010225	1.5	0.1	2	2.3	3	25	60	4
UR544 015010230	1.5	0.1	2	2.3	3	30	70	4
UR544 015010240	1.5	0.1	2	2.3	3	40	80	6
UR544 015010250	1.5	0.1	2	2.3	3	50	90	6
UR544 015020108	1.5	0.2	1	2.3	3	8	50	4
UR544 015020110	1.5	0.2	1	2.3	3	10	50	4
UR544 015020112	1.5	0.2	1	2.3	3	12	50	4
UR544 015020116	1.5	0.2	1	2.3	3	16	50	4
UR544 015020120	1.5	0.2	1	2.3	3	20	50	4
UR544 015020125	1.5	0.2	1	2.3	3	25	60	4

▶ 적용 피삭재

○ : 적합 ◎ : 매우 적합

H		P			K	N			M	S
열처리강		탄소강	합금강	프리하든강	주철	동	흑연	알루미늄	스테인리스	내열합금
SKD61 ~HRc55	SKD11 HRc55~	~HB225	HB225 ~325	HRc30~50	~FCD500					
○		○	◎	◎	○					

UR544 4날 테이퍼 넥 래디우스 엔드밀

Endmill

품목코드	DC	RE	BHTA	APMX	LU	LUX	OAL	DCONMS
	날경	Corner R	테이퍼각	날장	유효장	유효장	전장	자루경
UR544 015020130	1.5	0.2	1	2.3	3	30	70	4
UR544 015020140	1.5	0.2	1	2.3	3	40	80	4
UR544 015020150	1.5	0.2	1	2.3	3	50	90	4
UR544 015020208	1.5	0.2	2	2.3	3	8	50	4
UR544 015020210	1.5	0.2	2	2.3	3	10	50	4
UR544 015020212	1.5	0.2	2	2.3	3	12	50	4
UR544 015020216	1.5	0.2	2	2.3	3	16	50	4
UR544 015020220	1.5	0.2	2	2.3	3	20	50	4
UR544 015020225	1.5	0.2	2	2.3	3	25	60	4
UR544 015020230	1.5	0.2	2	2.3	3	30	70	4
UR544 015020240	1.5	0.2	2	2.3	3	40	80	6
UR544 015020250	1.5	0.2	2	2.3	3	50	90	6
UR544 015030108	1.5	0.3	1	2.3	3	8	50	4
UR544 015030110	1.5	0.3	1	2.3	3	10	50	4
UR544 015030112	1.5	0.3	1	2.3	3	12	50	4
UR544 015030116	1.5	0.3	1	2.3	3	16	50	4
UR544 015030120	1.5	0.3	1	2.3	3	20	50	4
UR544 015030125	1.5	0.3	1	2.3	3	25	60	4
UR544 015030130	1.5	0.3	1	2.3	3	30	70	4
UR544 015030140	1.5	0.3	1	2.3	3	40	80	4
UR544 015030150	1.5	0.3	1	2.3	3	50	90	4
UR544 015030208	1.5	0.3	2	2.3	3	8	50	4
UR544 015030210	1.5	0.3	2	2.3	3	10	50	4
UR544 015030212	1.5	0.3	2	2.3	3	12	50	4
UR544 015030216	1.5	0.3	2	2.3	3	16	50	4
UR544 015030220	1.5	0.3	2	2.3	3	20	50	4
UR544 015030225	1.5	0.3	2	2.3	3	25	60	4
UR544 015030230	1.5	0.3	2	2.3	3	30	70	4
UR544 015030240	1.5	0.3	2	2.3	3	40	80	6
UR544 015030250	1.5	0.3	2	2.3	3	50	90	6
UR544 020010110	2	0.1	1	2	5	10	50	4
UR544 020010112	2	0.1	1	2	5	12	50	4
UR544 020010116	2	0.1	1	2	5	16	50	4
UR544 020010120	2	0.1	1	2	5	20	50	4

Zamus Star

E-Star

U-Wing

Zamus Thunder

X-Star

S-Wing

A-Wing

Standard

Copper-Mate

Gra-Mate

▶ 적용 피삭재

○ : 적합 ◎ : 매우 적합

H		P			K	N			M	S
열처리강		탄소강	합금강	프리하든강	주철	동	흑연	알루미늄	스테인리스	내열합금
SKD61 ~HRc55	SKD11 HRc55~	~HB225	HB225 ~325	HRc30~50	~FCD500					
○		○	◎	◎	○					

UR544

4날 테이퍼 넥 래디우스 엔드밀

Endmill

품목코드	DC	RE	BHTA	APMX	LU	LUX	OAL	DCONMS
	날경	Corner R	테이퍼각	날장	유효장	유효장	전장	자루경
UR544 020010125	2	0.1	1	2	5	25	60	4
UR544 020010130	2	0.1	1	2	5	30	70	4
UR544 020010140	2	0.1	1	2	5	40	80	6
UR544 020010150	2	0.1	1	2	5	50	100	6
UR544 020010160	2	0.1	1	2	5	60	100	6
UR544 020010180	2	0.1	1	2	5	80	140	6
UR544 020010210	2	0.1	2	2	5	10	50	4
UR544 020010212	2	0.1	2	2	5	12	50	4
UR544 020010216	2	0.1	2	2	5	16	50	4
UR544 020010220	2	0.1	2	2	5	20	50	4
UR544 020010225	2	0.1	2	2	5	25	60	4
UR544 020010230	2	0.1	2	2	5	30	70	4
UR544 020010240	2	0.1	2	2	5	40	80	6
UR544 020010250	2	0.1	2	2	5	50	100	6
UR544 020010260	2	0.1	2	2	5	60	100	6
UR544 020010280	2	0.1	2	2	5	80	140	8
UR544 020020110	2	0.2	1	2	5	10	50	4
UR544 020020112	2	0.2	1	2	5	12	50	4
UR544 020020116	2	0.2	1	2	5	16	50	4
UR544 020020120	2	0.2	1	2	5	20	50	4
UR544 020020125	2	0.2	1	2	5	25	60	4
UR544 020020130	2	0.2	1	2	5	30	70	4
UR544 020020140	2	0.2	1	2	5	40	80	6
UR544 020020150	2	0.2	1	2	5	50	100	6
UR544 020020160	2	0.2	1	2	5	60	100	6
UR544 020020180	2	0.2	1	2	5	80	140	6
UR544 020020210	2	0.2	2	2	5	10	50	4
UR544 020020212	2	0.2	2	2	5	12	50	4
UR544 020020216	2	0.2	2	2	5	16	50	4
UR544 020020220	2	0.2	2	2	5	20	50	4
UR544 020020225	2	0.2	2	2	5	25	60	4
UR544 020020230	2	0.2	2	2	5	30	70	4
UR544 020020240	2	0.2	2	2	5	40	80	6
UR544 020020250	2	0.2	2	2	5	50	100	6

▶ 적용 피삭재

○ : 적합 ◎ : 매우 적합

H		P			K	N			M	S
열처리강		탄소강	합금강	프리하든강	주철	동	흑연	알루미늄	스테인리스	내열합금
SKD61 ~HRc55	SKD11 HRc55~	~HB225	HB225 ~325	HRc30~50	~FCD500					
○		○	◎	◎	○					

UR544 4날 테이퍼 넥 래디우스 엔드밀

Endmill

품목코드	DC	RE	BHTA	APMX	LU	LUX	OAL	DCONMS
	날경	Corner R	테이퍼각	날장	유효장	유효장	전장	자루경
UR544 020020260	2	0.2	2	2	5	60	100	6
UR544 020020280	2	0.2	2	2	5	80	140	8
UR544 020030110	2	0.3	1	2	5	10	50	4
UR544 020030112	2	0.3	1	2	5	12	50	4
UR544 020030116	2	0.3	1	2	5	16	50	4
UR544 020030120	2	0.3	1	2	5	20	50	4
UR544 020030125	2	0.3	1	2	5	25	60	4
UR544 020030130	2	0.3	1	2	5	30	70	4
UR544 020030140	2	0.3	1	2	5	40	80	6
UR544 020030150	2	0.3	1	2	5	50	100	6
UR544 020030160	2	0.3	1	2	5	60	100	6
UR544 020030180	2	0.3	1	2	5	80	140	6
UR544 020030210	2	0.3	2	2	5	10	50	4
UR544 020030212	2	0.3	2	2	5	12	50	4
UR544 020030216	2	0.3	2	2	5	16	50	4
UR544 020030220	2	0.3	2	2	5	20	50	4
UR544 020030225	2	0.3	2	2	5	25	60	4
UR544 020030230	2	0.3	2	2	5	30	70	4
UR544 020030240	2	0.3	2	2	5	40	80	6
UR544 020030250	2	0.3	2	2	5	50	100	6
UR544 020030260	2	0.3	2	2	5	60	100	6
UR544 020030280	2	0.3	2	2	5	80	140	8
UR544 020050110	2	0.5	1	2	5	10	50	4
UR544 020050112	2	0.5	1	2	5	12	50	4
UR544 020050116	2	0.5	1	2	5	16	50	4
UR544 020050120	2	0.5	1	2	5	20	50	4
UR544 020050125	2	0.5	1	2	5	25	60	4
UR544 020050130	2	0.5	1	2	5	30	70	4
UR544 020050140	2	0.5	1	2	5	40	80	6
UR544 020050150	2	0.5	1	2	5	50	100	6
UR544 020050160	2	0.5	1	2	5	60	100	6
UR544 020050180	2	0.5	1	2	5	80	140	6
UR544 020050210	2	0.5	2	2	5	10	50	4
UR544 020050212	2	0.5	2	2	5	12	50	4

Zamus Star

E-Star

U-Wing

Zamus Thunder

X-Star

S-Wing

A-Wing

Standard

Copper-Mate

Gra-Mate

▶ 적용 피삭재

○ : 적합 ◎ : 매우 적합

H		P			K	N			M	S
열처리강		탄소강	합금강	프리하든강	주철	동	흑연	알루미늄	스테인리스	내열합금
SKD61 ~HRc55	SKD11 HRc55~	~HB225	HB225 ~325	HRc30~50	~FCD500					
○		○	◎	◎	○					

UR544

4날 테이퍼 넥 래디우스 엔드밀

Endmill

품목코드	DC	RE	BHTA	APMX	LU	LUX	OAL	DCONMS
	날경	Corner R	테이퍼각	날장	유효장	유효장	전장	자루경
UR544 020050216	2	0.5	2	2	5	16	50	4
UR544 020050220	2	0.5	2	2	5	20	50	4
UR544 020050225	2	0.5	2	2	5	25	60	4
UR544 020050230	2	0.5	2	2	5	30	70	4
UR544 020050240	2	0.5	2	2	5	40	80	6
UR544 020050250	2	0.5	2	2	5	50	100	6
UR544 020050260	2	0.5	2	2	5	60	100	6
UR544 020050280	2	0.5	2	2	5	80	140	8
UR544 030020116	3	0.2	1	4.5	6	16	60	6
UR544 030020120	3	0.2	1	4.5	6	20	65	6
UR544 030020130	3	0.2	1	4.5	6	30	70	6
UR544 030020140	3	0.2	1	4.5	6	40	80	6
UR544 030020150	3	0.2	1	4.5	6	50	90	6
UR544 030020160	3	0.2	1	4.5	6	60	100	6
UR544 030020216	3	0.2	2	4.5	6	16	60	6
UR544 030020220	3	0.2	2	4.5	6	20	65	6
UR544 030020230	3	0.2	2	4.5	6	30	70	6
UR544 030020240	3	0.2	2	4.5	6	40	80	6
UR544 030020250	3	0.2	2	4.5	6	50	90	8
UR544 030020260	3	0.2	2	4.5	6	60	100	8
UR544 030020270	3	0.2	2	4.5	6	70	120	8
UR544 030030116	3	0.3	1	4.5	6	16	60	6
UR544 030030120	3	0.3	1	4.5	6	20	65	6
UR544 030030130	3	0.3	1	4.5	6	30	70	6
UR544 030030140	3	0.3	1	4.5	6	40	80	6
UR544 030030150	3	0.3	1	4.5	6	50	90	6
UR544 030030160	3	0.3	1	4.5	6	60	100	6
UR544 030030216	3	0.3	2	4.5	6	16	60	6
UR544 030030220	3	0.3	2	4.5	6	20	65	6
UR544 030030230	3	0.3	2	4.5	6	30	70	6
UR544 030030240	3	0.3	2	4.5	6	40	80	6
UR544 030030250	3	0.3	2	4.5	6	50	90	8
UR544 030030260	3	0.3	2	4.5	6	60	100	8
UR544 030030270	3	0.3	2	4.5	6	70	120	8

▶ 적용 피삭재

○ : 적합 ◎ : 매우 적합

H		P			K	N			M	S
열처리강		탄소강	합금강	프리하든강	주철	동	흑연	알루미늄	스테인리스	내열합금
SKD61 ~HRc55	SKD11 HRc55~	~HB225	HB225 ~325	HRc30~50	~FCD500					
○		○	◎	◎	○					

UR544 4날 테이퍼 넥 래디우스 엔드밀

Endmill

품목코드	DC	RE	BHTA	APMX	LU	LUX	OAL	DCONMS
	날경	Corner R	테이퍼각	날장	유효장	유효장	전장	자루경
UR544 030050116	3	0.5	1	4.5	6	16	60	6
UR544 030050120	3	0.5	1	4.5	6	20	65	6
UR544 030050130	3	0.5	1	4.5	6	30	70	6
UR544 030050140	3	0.5	1	4.5	6	40	80	6
UR544 030050150	3	0.5	1	4.5	6	50	90	6
UR544 030050160	3	0.5	1	4.5	6	60	100	6
UR544 030050216	3	0.5	2	4.5	6	16	60	6
UR544 030050220	3	0.5	2	4.5	6	20	65	6
UR544 030050230	3	0.5	2	4.5	6	30	70	6
UR544 030050240	3	0.5	2	4.5	6	40	80	6
UR544 030050250	3	0.5	2	4.5	6	50	90	8
UR544 030050260	3	0.5	2	4.5	6	60	100	8
UR544 030050270	3	0.5	2	4.5	6	70	120	8
UR544 040020140	4	0.2	1	6	8	40	90	6
UR544 040020150	4	0.2	1	6	8	50	100	6
UR544 040020160	4	0.2	1	6	8	60	110	6
UR544 040020170	4	0.2	1	6	8	70	120	8
UR544 040020240	4	0.2	2	6	8	40	90	8
UR544 040020250	4	0.2	2	6	8	50	100	8
UR544 040020260	4	0.2	2	6	8	60	110	8
UR544 040020270	4	0.2	2	6	8	70	120	10
UR544 040030140	4	0.3	1	6	8	40	90	6
UR544 040030150	4	0.3	1	6	8	50	100	6
UR544 040030160	4	0.3	1	6	8	60	110	6
UR544 040030170	4	0.3	1	6	8	70	120	8
UR544 040030240	4	0.3	2	6	8	40	90	8
UR544 040030250	4	0.3	2	6	8	50	100	8
UR544 040030260	4	0.3	2	6	8	60	110	8
UR544 040030270	4	0.3	2	6	8	70	120	10
UR544 040050140	4	0.5	1	6	8	40	90	6
UR544 040050150	4	0.5	1	6	8	50	100	6
UR544 040050160	4	0.5	1	6	8	60	110	6
UR544 040050170	4	0.5	1	6	8	70	120	8
UR544 040050240	4	0.5	2	6	8	40	90	8

Zamus Star
E-Star
U-Wing
Zamus Thunder
X-Star
S-Wing
A-Wing
Standard
Copper-Mate
Gra-Mate

▶ 적용 피삭재

○ : 적합 ◎ : 매우 적합

H		P			K	N			M	S
열처리강		탄소강	합금강	프리하든강	주철	동	흑연	알루미늄	스테인리스	내열합금
SKD61 ~HRc55	SKD11 HRc55~	~HB225	HB225 ~325	HRc30~50	~FCD500					
○		○	◎	◎	○					

UR544

4날 테이퍼 넥 래디우스 엔드밀

Endmill

품목코드	DC	RE	BHTA	APMX	LU	LUX	OAL	DCONMS
	날경	Corner R	테이퍼각	날장	유효장	유효장	전장	자루경
UR544 040050250	4	0.5	2	6	8	50	100	8
UR544 040050260	4	0.5	2	6	8	60	110	8
UR544 040050270	4	0.5	2	6	8	70	120	10

Zamus Star

E-Star

U-Wing

Zamus Thunder

X-Star

S-Wing

A-Wing

Standard

Copper-Mate

Gra-Mate

▶ 적용 피삭재

○ : 적합 ◎ : 매우 적합

H		P			K	N			M	S
열처리강		탄소강	합금강	프리하든강	주철	동	흑연	알루미늄	스테인리스	내열합금
SKD61 ~HRc55	SKD11 HRc55~	~HB225	HB225 ~325	HRc30~50	~FCD500					
○		○	◎	◎	○					

UXR504 4날 멀티 헬릭스 라디우스 엔드밀

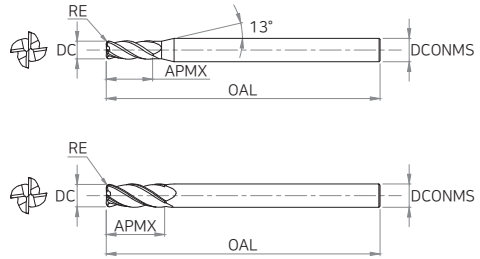

▶ 제품허용공차

날경(DC)		자루경
~ Ø6	0 ~ -0.012	
Ø8 ~ Ø20	0 ~ -0.015	h5

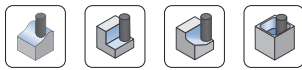

품목코드	DC	RE	APMX	OAL	DCONMS	품목코드	DC	RE	APMX	OAL	DCONMS
	날경	Corner R	날장	전장	자루경		날경	Corner R	날장	전장	자루경
UXR504 010005	1	0.05	2.5	50	6	UXR504 02505	2.5	0.5	7	60	6
UXR504 01001	1	0.1	2.5	50	6	UXR504 03001	3	0.1	8	60	6
UXR504 01002	1	0.2	2.5	50	6	UXR504 03002	3	0.2	8	60	6
UXR504 01003	1	0.3	2.5	50	6	UXR504 03003	3	0.3	8	60	6
UXR504 012005	1.2	0.05	3	50	6	UXR504 03005	3	0.5	8	60	6
UXR504 01201	1.2	0.1	3	50	6	UXR504 03010	3	1	8	60	6
UXR504 01202	1.2	0.2	3	50	6	UXR504 03501	3.5	0.1	10	70	6
UXR504 01203	1.2	0.3	3	50	6	UXR504 03502	3.5	0.2	10	70	6
UXR504 015005	1.5	0.05	4	50	6	UXR504 03503	3.5	0.3	10	70	6
UXR504 01501	1.5	0.1	4	50	6	UXR504 03505	3.5	0.5	10	70	6
UXR504 01502	1.5	0.2	4	50	6	UXR504 04001	4	0.1	10	70	6
UXR504 01503	1.5	0.3	4	50	6	UXR504 04001100S4	4	0.1	10	100	4
UXR504 01505	1.5	0.5	4	50	6	UXR504 04001S4	4	0.1	10	70	4
UXR504 02001	2	0.1	6	50	6	UXR504 04002	4	0.2	10	70	6
UXR504 02002	2	0.2	6	50	6	UXR504 04002100S4	4	0.2	10	100	4
UXR504 02003	2	0.3	6	50	6	UXR504 04002S4	4	0.2	10	70	4
UXR504 02005	2	0.5	6	50	6	UXR504 04003	4	0.3	10	70	6
UXR504 02501	2.5	0.1	7	60	6	UXR504 04003100S4	4	0.3	10	100	4
UXR504 02502	2.5	0.2	7	60	6	UXR504 04003S4	4	0.3	10	70	4
UXR504 02503	2.5	0.3	7	60	6	UXR504 04005	4	0.5	10	70	6

▶ 적용 피삭재

○ : 적합 ◎ : 매우 적합

H		P			K	N			M	S
열처리강		탄소강	합금강	프리하든강	주철	동	흑연	알루미늄	스테인리스	내열합금
SKD61 ~HRc55	SKD11 HRc55~	~HB225	HB225 ~325	HRc30~50	~FCD500					
○		○	◎	◎	○					

UXR504 4날 멀티 헬릭스 래디우스 엔드밀

Endmill

	품목코드						품목코드					
	DC 날경	RE Corner R	APMX 날장	OAL 전장	DCONMS 자루경		DC 날경	RE Corner R	APMX 날장	OAL 전장	DCONMS 자루경	
Zamus Star	UXR504 04005100S4	4	0.5	10	100	4	UXR504 07001	7	0.1	16	90	8
	UXR504 04005S4	4	0.5	10	70	4	UXR504 07002	7	0.2	16	90	8
	UXR504 04010	4	1	10	70	6	UXR504 07003	7	0.3	16	90	8
	UXR504 04010100S4	4	1	10	100	4	UXR504 07005	7	0.5	16	90	8
	UXR504 04010S4	4	1	10	70	4	UXR504 07010	7	1	16	90	8
E-Star	UXR504 04501	4.5	0.1	11	80	6	UXR504 07020	7	2	16	90	8
	UXR504 04502	4.5	0.2	11	80	6	UXR504 08001	8	0.1	20	100	8
	UXR504 04503	4.5	0.3	11	80	6	UXR504 08002	8	0.2	20	100	8
U-Wing	UXR504 04505	4.5	0.5	11	80	6	UXR504 08003	8	0.3	20	100	8
	UXR504 05001	5	0.1	13	90	6	UXR504 08003070	8	0.3	20	70	8
	UXR504 05002	5	0.2	13	90	6	UXR504 08005	8	0.5	20	100	8
	UXR504 05003	5	0.3	13	90	6	UXR504 08005070	8	0.5	20	70	8
	UXR504 05005	5	0.5	13	90	6	UXR504 08005120	8	0.5	20	120	8
Zamus Thunder	UXR504 05010	5	1	13	90	6	UXR504 08005150	8	0.5	20	150	8
	UXR504 05501	5.5	0.1	13	90	6	UXR504 08010	8	1	20	100	8
	UXR504 05502	5.5	0.2	13	90	6	UXR504 08010070	8	1	20	70	8
X-Star	UXR504 05503	5.5	0.3	13	90	6	UXR504 08010120	8	1	20	120	8
	UXR504 05505	5.5	0.5	13	90	6	UXR504 08010150	8	1	20	150	8
	UXR504 05510	5.5	1	13	90	6	UXR504 08015	8	1.5	20	100	8
S-Wing	UXR504 06001	6	0.1	15	90	6	UXR504 08015070	8	1.5	20	70	8
	UXR504 06001060	6	0.1	15	60	6	UXR504 08020	8	2	20	100	8
	UXR504 06002	6	0.2	15	90	6	UXR504 08020070	8	2	20	70	8
A-Wing	UXR504 06002060	6	0.2	15	60	6	UXR504 08025	8	2.5	20	100	8
	UXR504 06003	6	0.3	15	90	6	UXR504 08030	8	3	20	100	8
	UXR504 06005	6	0.5	15	90	6	UXR504 10001	10	0.1	25	100	10
Standard	UXR504 06005060	6	0.5	15	60	6	UXR504 10002	10	0.2	25	100	10
	UXR504 06005110	6	0.5	15	110	6	UXR504 10003	10	0.3	25	100	10
	UXR504 06005130	6	0.5	15	130	6	UXR504 10003075	10	0.3	25	75	10
	UXR504 06010	6	1	15	90	6	UXR504 10005	10	0.5	25	100	10
	UXR504 06010060	6	1	15	60	6	UXR504 10005075	10	0.5	25	75	10
Copper-Mate	UXR504 06010110	6	1	15	110	6	UXR504 10005130	10	0.5	22	130	10
	UXR504 06010130	6	1	15	130	6	UXR504 10005150	10	0.5	22	150	10
	UXR504 06015	6	1.5	15	90	6	UXR504 10010	10	1	25	100	10
Gra-Mate	UXR504 06020	6	2	15	90	6	UXR504 10010075	10	1	25	75	10

▶ 적용 피삭재

○ : 적합 ◎ : 매우 적합

H		P			K	N			M	S
열처리강		탄소강	합금강	프리하든강	주철	동	흑연	알루미늄	스테인리스	내열합금
SKD61 ~HRc55	SKD11 HRc55~	~HB225	HB225 ~325	HRc30~50	~FCD500					
○		○	◎	◎	○					

UXR504 4날 멀티 헬릭스 래디우스 엔드밀

Endmill

품목코드	DC	RE	APMX	OAL	DCONMS	품목코드	DC	RE	APMX	OAL	DCONMS
	날경	Corner R	날장	전장	자루경		날경	Corner R	날장	전장	자루경
UXR504 10010130	10	1	22	130	10	UXR504 12025	12	2.5	30	110	12
UXR504 10010150	10	1	22	150	10	UXR504 12025080	12	2.5	30	80	12
UXR504 10015	10	1.5	25	100	10	UXR504 12030	12	3	30	110	12
UXR504 10020	10	2	25	100	10	UXR504 12030080	12	3	30	80	12
UXR504 10025	10	2.5	25	100	10	UXR504 12040	12	4	30	110	12
UXR504 10030	10	3	25	100	10	UXR504 12050	12	5	30	110	12
UXR504 10040	10	4	25	100	10	UXR504 14005	14	0.5	35	150	16
UXR504 11002	11	0.2	25	110	12	UXR504 14010	14	1	35	150	16
UXR504 11003	11	0.3	25	110	12	UXR504 14020	14	2	35	150	16
UXR504 11005	11	0.5	25	110	12	UXR504 16005	16	0.5	40	100	16
UXR504 11010	11	1	25	110	12	UXR504 16005150	16	0.5	40	150	16
UXR504 11020	11	2	25	110	12	UXR504 16010	16	1	40	100	16
UXR504 12001	12	0.1	30	110	12	UXR504 16010150	16	1	40	150	16
UXR504 12002	12	0.2	30	110	12	UXR504 16015	16	1.5	40	100	16
UXR504 12003	12	0.3	30	110	12	UXR504 16015150	16	1.5	40	150	16
UXR504 12003080	12	0.3	30	80	12	UXR504 16020	16	2	40	100	16
UXR504 12005	12	0.5	30	110	12	UXR504 16020150	16	2	40	150	16
UXR504 12005080	12	0.5	30	80	12	UXR504 16030	16	3	40	100	16
UXR504 12005130	12	0.5	30	130	12	UXR504 20005	20	0.5	45	110	20
UXR504 15005150	12	0.5	30	150	12	UXR504 20005150	20	0.5	45	150	20
UXR504 12010	12	1	30	110	12	UXR504 20010	20	1	45	110	20
UXR504 12010080	12	1	30	80	12	UXR504 20010150	20	1	45	150	20
UXR504 12010130	12	1	30	130	12	UXR504 20015	20	1.5	45	110	20
UXR504 12010150	12	1	30	150	12	UXR504 20015150	20	1.5	45	150	20
UXR504 12015	12	1.5	30	110	12	UXR504 20020	20	2	45	110	20
UXR504 12015080	12	1.5	30	80	12	UXR504 20020150	20	2	45	150	20
UXR504 12020	12	2	30	110	12	UXR504 20030	20	3	45	110	20
UXR504 12020080	12	2	30	80	12						

Zamus Star
E-Star
U-Wing
Zamus Thunder
X-Star
S-Wing
A-Wing
Standard
Copper-Mate
Gra-Mate

▶ 적용 피삭재

○ : 적합 ◎ : 매우 적합

H		P			K	N			M	S
열처리강		탄소강	합금강	프리하든강	주철	동	흑연	알루미늄	스테인리스	내열합금
SKD61 ~HRc55	SKD11 HRc55~	~HB225	HB225 ~325	HRc30~50	~FCD500					
○		○	◎	◎	○					

UXR514 4날 멀티 헬릭스 넥 래디우스 엔드밀

Endmill

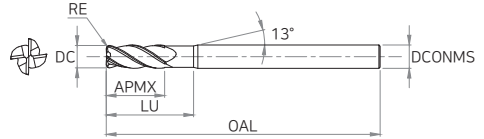
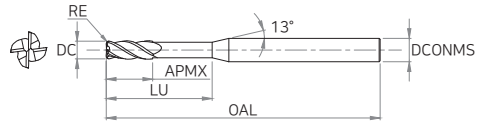

Zamus Star

E-Star

▶ 제품허용공차

날경(DC)		자루경
Ø1 ~ Ø20	0 ~ -0.03	h5

U-Wing

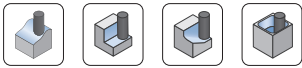

Zamus Thunder

품목코드	DC	RE	APMX	LU	OAL	DCONMS	품목코드	DC	RE	APMX	LU	OAL	DCONMS
	날경	Corner R	날장	유효장	전장	자루경		날경	Corner R	날장	유효장	전장	자루경
UXR514 01000503	1	0.05	1.5	3	50	4	UXR514 0100206	1	0.2	1.5	6	50	4
UXR514 01000504	1	0.05	1.5	4	50	4	UXR514 0100208	1	0.2	1.5	8	50	4
UXR514 01000506	1	0.05	1.5	6	50	4	UXR514 0100210	1	0.2	1.5	10	50	4
UXR514 01000508	1	0.05	1.5	8	50	4	UXR514 0100212	1	0.2	1.5	12	50	4
UXR514 01000510	1	0.05	1.5	10	50	4	UXR514 0100214	1	0.2	1.5	14	50	4
UXR514 01000512	1	0.05	1.5	12	50	4	UXR514 0100216	1	0.2	1.5	16	50	4
UXR514 01000514	1	0.05	1.5	14	50	4	UXR514 0100220	1	0.2	1.5	20	50	4
UXR514 01000516	1	0.05	1.5	16	50	4	UXR514 0100303	1	0.3	1.5	3	50	4
UXR514 01000520	1	0.05	1.5	20	50	4	UXR514 0100304	1	0.3	1.5	4	50	4
UXR514 0100103	1	0.1	1.5	3	50	4	UXR514 0100306	1	0.3	1.5	6	50	4
UXR514 0100104	1	0.1	1.5	4	50	4	UXR514 0100308	1	0.3	1.5	8	50	4
UXR514 0100106	1	0.1	1.5	6	50	4	UXR514 0100310	1	0.3	1.5	10	50	4
UXR514 0100108	1	0.1	1.5	8	50	4	UXR514 0100312	1	0.3	1.5	12	50	4
UXR514 0100110	1	0.1	1.5	10	50	4	UXR514 0100314	1	0.3	1.5	14	50	4
UXR514 0100112	1	0.1	1.5	12	50	4	UXR514 0100316	1	0.3	1.5	16	50	4
UXR514 0100114	1	0.1	1.5	14	50	4	UXR514 0100320	1	0.3	1.5	20	50	4
UXR514 0100116	1	0.1	1.5	16	50	4	UXR514 01200503	1.2	0.05	1.8	3	50	4
UXR514 0100120	1	0.1	1.5	20	50	4	UXR514 01200504	1.2	0.05	1.8	4	50	4
UXR514 0100203	1	0.2	1.5	3	50	4	UXR514 01200506	1.2	0.05	1.8	6	50	4
UXR514 0100204	1	0.2	1.5	4	50	4	UXR514 01200508	1.2	0.05	1.8	8	50	4

Copper -Mate

Gra -Mate

▶ 적용 피삭재

○ : 적합 ◎ : 매우 적합

H		P			K	N			M	S
열처리강		탄소강	합금강	프리하든강	주철	동	흑연	알루미늄	스테인리스	내열합금
SKD61 ~HRc55	SKD11 HRc55~	~HB225	HB225 ~325	HRC30~50	~FCD500					
○		○	◎	◎	○					

UXR514

4날 멀티 헬릭스 넥 래디우스 엔드밀

Endmill

품목코드	DC	RE	APMX	LU	OAL	DCONMS	품목코드	DC	RE	APMX	LU	OAL	DCONMS
	날경	Corner R	날장	유효장	전장	자루경		날경	Corner R	날장	유효장	전장	자루경
UXR514 01200510	1.2	0.05	1.8	10	50	4	UXR514 01500516	1.5	0.05	2.3	16	50	4
UXR514 01200512	1.2	0.05	1.8	12	50	4	UXR514 01500520	1.5	0.05	2.3	20	50	4
UXR514 01200516	1.2	0.05	1.8	16	50	4	UXR514 01500522	1.5	0.05	2.3	22	60	4
UXR514 01200520	1.2	0.05	1.8	20	50	4	UXR514 01500526	1.5	0.05	2.3	26	60	4
UXR514 0120103	1.2	0.1	1.8	3	50	4	UXR514 0150104	1.5	0.1	2.3	4	50	4
UXR514 0120104	1.2	0.1	1.8	4	50	4	UXR514 0150106	1.5	0.1	2.3	6	50	4
UXR514 0120106	1.2	0.1	1.8	6	50	4	UXR514 0150108	1.5	0.1	2.3	8	50	4
UXR514 0120108	1.2	0.1	1.8	8	50	4	UXR514 0150110	1.5	0.1	2.3	10	50	4
UXR514 0120110	1.2	0.1	1.8	10	50	4	UXR514 0150112	1.5	0.1	2.3	12	50	4
UXR514 0120112	1.2	0.1	1.8	12	50	4	UXR514 0150114	1.5	0.1	2.3	14	50	4
UXR514 0120116	1.2	0.1	1.8	16	50	4	UXR514 0150116	1.5	0.1	2.3	16	50	4
UXR514 0120120	1.2	0.1	1.8	20	50	4	UXR514 0150120	1.5	0.1	2.3	20	50	4
UXR514 0120203	1.2	0.2	1.8	3	50	4	UXR514 0150122	1.5	0.1	2.3	22	60	4
UXR514 0120204	1.2	0.2	1.8	4	50	4	UXR514 0150126	1.5	0.1	2.3	26	60	4
UXR514 0120206	1.2	0.2	1.8	6	50	4	UXR514 0150204	1.5	0.2	2.3	4	50	4
UXR514 0120208	1.2	0.2	1.8	8	50	4	UXR514 0150206	1.5	0.2	2.3	6	50	4
UXR514 0120210	1.2	0.2	1.8	10	50	4	UXR514 0150208	1.5	0.2	2.3	8	50	4
UXR514 0120212	1.2	0.2	1.8	12	50	4	UXR514 0150210	1.5	0.2	2.3	10	50	4
UXR514 0120216	1.2	0.2	1.8	16	50	4	UXR514 0150212	1.5	0.2	2.3	12	50	4
UXR514 0120220	1.2	0.2	1.8	20	50	4	UXR514 0150214	1.5	0.2	2.3	14	50	4
UXR514 0120303	1.2	0.3	1.8	3	50	4	UXR514 0150216	1.5	0.2	2.3	16	50	4
UXR514 0120304	1.2	0.3	1.8	4	50	4	UXR514 0150220	1.5	0.2	2.3	20	50	4
UXR514 0120306	1.2	0.3	1.8	6	50	4	UXR514 0150222	1.5	0.2	2.3	22	60	4
UXR514 0120308	1.2	0.3	1.8	8	50	4	UXR514 0150226	1.5	0.2	2.3	26	60	4
UXR514 0120310	1.2	0.3	1.8	10	50	4	UXR514 0150304	1.5	0.3	2.3	4	50	4
UXR514 0120312	1.2	0.3	1.8	12	50	4	UXR514 0150306	1.5	0.3	2.3	6	50	4
UXR514 0120316	1.2	0.3	1.8	16	50	4	UXR514 0150308	1.5	0.3	2.3	8	50	4
UXR514 0120320	1.2	0.3	1.8	20	50	4	UXR514 0150310	1.5	0.3	2.3	10	50	4
UXR514 01500504	1.5	0.05	2.3	4	50	4	UXR514 0150312	1.5	0.3	2.3	12	50	4
UXR514 01500506	1.5	0.05	2.3	6	50	4	UXR514 0150314	1.5	0.3	2.3	14	50	4
UXR514 01500508	1.5	0.05	2.3	8	50	4	UXR514 0150316	1.5	0.3	2.3	16	50	4
UXR514 01500510	1.5	0.05	2.3	10	50	4	UXR514 0150320	1.5	0.3	2.3	20	50	4
UXR514 01500512	1.5	0.05	2.3	12	50	4	UXR514 0150322	1.5	0.3	2.3	22	60	4
UXR514 01500514	1.5	0.05	2.3	14	50	4	UXR514 0150326	1.5	0.3	2.3	26	60	4

Zamus Star

E-Star

U-Wing

Zamus Thunder

X-Star

S-Wing

A-Wing

Standard

Copper-Mate

Gra-Mate

▶ 적용 피삭재

○ : 적합 ◎ : 매우 적합

H		P			K	N			M	S
열처리강		탄소강	합금강	프리하트강	주철	동	흑연	알루미늄	스테인리스	내열합금
SKD61 ~HRc55	SKD11 HRc55~	~HB225	HB225 ~325	HRc30~50	~FCD500					
○		○	◎	◎	○					

UXR514

4날 멀티 헬릭스 넥 래디우스 엔드밀

Endmill

종류	품목코드	DC	RE	APMX	LU	OAL	DCONMS	품목코드	DC	RE	APMX	LU	OAL	DCONMS
		날경	Corner R	날장	유효장	전장	자루경		날경	Corner R	날장	유효장	전장	자루경
Zamus Star	UXR514 0150504	1.5	0.5	2.3	4	50	4	UXR514 0200314	2	0.3	3	14	50	4
	UXR514 0150506	1.5	0.5	2.3	6	50	4	UXR514 0200316	2	0.3	3	16	50	4
	UXR514 0150508	1.5	0.5	2.3	8	50	4	UXR514 0200320	2	0.3	3	20	50	4
	UXR514 0150510	1.5	0.5	2.3	10	50	4	UXR514 0200322	2	0.3	3	22	60	4
	UXR514 0150512	1.5	0.5	2.3	12	50	4	UXR514 0200326	2	0.3	3	26	60	4
E-Star	UXR514 0150514	1.5	0.5	2.3	14	50	4	UXR514 0200330	2	0.3	3	30	70	4
	UXR514 0150516	1.5	0.5	2.3	16	50	4	UXR514 0200506	2	0.5	3	6	50	4
	UXR514 0150520	1.5	0.5	2.3	20	50	4	UXR514 0200508	2	0.5	3	8	50	4
U-Wing	UXR514 0150522	1.5	0.5	2.3	22	60	4	UXR514 0200510	2	0.5	3	10	50	4
	UXR514 0150526	1.5	0.5	2.3	26	60	4	UXR514 0200512	2	0.5	3	12	50	4
	UXR514 0200106	2	0.1	3	6	50	4	UXR514 0200514	2	0.5	3	14	50	4
	UXR514 0200108	2	0.1	3	8	50	4	UXR514 0200516	2	0.5	3	16	50	4
Zamus Thunder	UXR514 0200110	2	0.1	3	10	50	4	UXR514 0200520	2	0.5	3	20	50	4
	UXR514 0200112	2	0.1	3	12	50	4	UXR514 0200522	2	0.5	3	22	60	4
	UXR514 0200114	2	0.1	3	14	50	4	UXR514 0200526	2	0.5	3	26	60	4
	UXR514 0200116	2	0.1	3	16	50	4	UXR514 0200530	2	0.5	3	30	70	4
X-Star	UXR514 0200120	2	0.1	3	20	50	4	UXR514 0250108	2.5	0.1	4	8	50	4
	UXR514 0200122	2	0.1	3	22	60	4	UXR514 0250110	2.5	0.1	4	10	50	4
	UXR514 0200126	2	0.1	3	26	60	4	UXR514 0250112	2.5	0.1	4	12	50	4
S-Wing	UXR514 0200130	2	0.1	3	30	70	4	UXR514 0250114	2.5	0.1	4	14	50	4
	UXR514 0200206	2	0.2	3	6	50	4	UXR514 0250116	2.5	0.1	4	16	50	4
	UXR514 0200208	2	0.2	3	8	50	4	UXR514 0250120	2.5	0.1	4	20	50	4
A-Wing	UXR514 0200210	2	0.2	3	10	50	4	UXR514 0250126	2.5	0.1	4	26	60	4
	UXR514 0200212	2	0.2	3	12	50	4	UXR514 0250130	2.5	0.1	4	30	70	4
	UXR514 0200214	2	0.2	3	14	50	4	UXR514 0250208	2.5	0.2	4	8	50	4
	UXR514 0200216	2	0.2	3	16	50	4	UXR514 0250210	2.5	0.2	4	10	50	4
Standard	UXR514 0200220	2	0.2	3	20	50	4	UXR514 0250212	2.5	0.2	4	12	50	4
	UXR514 0200222	2	0.2	3	22	60	4	UXR514 0250214	2.5	0.2	4	14	50	4
	UXR514 0200226	2	0.2	3	26	60	4	UXR514 0250216	2.5	0.2	4	16	50	4
Copper-Mate	UXR514 0200230	2	0.2	3	30	70	4	UXR514 0250220	2.5	0.2	4	20	50	4
	UXR514 0200306	2	0.3	3	6	50	4	UXR514 0250226	2.5	0.2	4	26	60	4
	UXR514 0200308	2	0.3	3	8	50	4	UXR514 0250230	2.5	0.2	4	30	70	4
Gra-Mate	UXR514 0200310	2	0.3	3	10	50	4	UXR514 0250308	2.5	0.3	4	8	50	4
	UXR514 0200312	2	0.3	3	12	50	4	UXR514 0250310	2.5	0.3	4	10	50	4

▶ 적용 피삭재

○ : 적합 ◎ : 매우 적합

H		P			K	N			M	S
열처리강		탄소강	합금강	프리하든강	주철	동	흑연	알루미늄	스테인리스	내열합금
SKD61 ~HRc55	SKD11 HRc55~	~HB225	HB225 ~325	Hrc30~50	~FCD500					
○		○	◎	◎	○					

UXR514

4날 멀티 헬릭스 넥 래디우스 엔드밀

Endmill

품목코드	DC	RE	APMX	LU	OAL	DCONMS	품목코드	DC	RE	APMX	LU	OAL	DCONMS
	날경	Corner R	날장	유효장	전장	자루경		날경	Corner R	날장	유효장	전장	자루경
UXR514 0250312	2.5	0.3	4	12	50	4	UXR514 0300308	3	0.3	4.5	8	50	6
UXR514 0250314	2.5	0.3	4	14	50	4	UXR514 0300310	3	0.3	4.5	10	50	6
UXR514 0250316	2.5	0.3	4	16	50	4	UXR514 0300312	3	0.3	4.5	12	50	6
UXR514 0250320	2.5	0.3	4	20	50	4	UXR514 0300314	3	0.3	4.5	14	60	6
UXR514 0250326	2.5	0.3	4	26	60	4	UXR514 0300316	3	0.3	4.5	16	60	6
UXR514 0250330	2.5	0.3	4	30	70	4	UXR514 0300320	3	0.3	4.5	20	60	6
UXR514 0250508	2.5	0.5	4	8	50	4	UXR514 0300326	3	0.3	4.5	26	65	6
UXR514 0250510	2.5	0.5	4	10	50	4	UXR514 0300330	3	0.3	4.5	30	70	6
UXR514 0250512	2.5	0.5	4	12	50	4	UXR514 0300335	3	0.3	4.5	35	70	6
UXR514 0250514	2.5	0.5	4	14	50	4	UXR514 0300340	3	0.3	4.5	40	80	6
UXR514 0250516	2.5	0.5	4	16	50	4	UXR514 0300508	3	0.5	4.5	8	50	6
UXR514 0250520	2.5	0.5	4	20	50	4	UXR514 0300510	3	0.5	4.5	10	50	6
UXR514 0250526	2.5	0.5	4	26	60	4	UXR514 0300512	3	0.5	4.5	12	50	6
UXR514 0250530	2.5	0.5	4	30	70	4	UXR514 0300514	3	0.5	4.5	14	60	6
UXR514 0300108	3	0.1	4.5	8	50	6	UXR514 0300516	3	0.5	4.5	16	60	6
UXR514 0300110	3	0.1	4.5	10	50	6	UXR514 0300520	3	0.5	4.5	20	60	6
UXR514 0300112	3	0.1	4.5	12	50	6	UXR514 0300526	3	0.5	4.5	26	65	6
UXR514 0300114	3	0.1	4.5	14	60	6	UXR514 0300530	3	0.5	4.5	30	70	6
UXR514 0300116	3	0.1	4.5	16	60	6	UXR514 0300535	3	0.5	4.5	35	70	6
UXR514 0300120	3	0.1	4.5	20	60	6	UXR514 0300540	3	0.5	4.5	40	80	6
UXR514 0300126	3	0.1	4.5	26	65	6	UXR514 0301008	3	1	4.5	8	50	6
UXR514 0300130	3	0.1	4.5	30	70	6	UXR514 0301010	3	1	4.5	10	50	6
UXR514 0300135	3	0.1	4.5	35	70	6	UXR514 0301012	3	1	4.5	12	50	6
UXR514 0300140	3	0.1	4.5	40	80	6	UXR514 0301014	3	1	4.5	14	60	6
UXR514 0300208	3	0.2	4.5	8	50	6	UXR514 0301016	3	1	4.5	16	60	6
UXR514 0300210	3	0.2	4.5	10	50	6	UXR514 0301020	3	1	4.5	20	60	6
UXR514 0300212	3	0.2	4.5	12	50	6	UXR514 0301026	3	1	4.5	26	65	6
UXR514 0300214	3	0.2	4.5	14	60	6	UXR514 0301030	3	1	4.5	30	70	6
UXR514 0300216	3	0.2	4.5	16	60	6	UXR514 0301035	3	1	4.5	35	70	6
UXR514 0300220	3	0.2	4.5	20	60	6	UXR514 0301040	3	1	4.5	40	80	6
UXR514 0300226	3	0.2	4.5	26	65	6	UXR514 0400110	4	0.1	6	10	50	6
UXR514 0300230	3	0.2	4.5	30	70	6	UXR514 0400112	4	0.1	6	12	50	6
UXR514 0300235	3	0.2	4.5	35	70	6	UXR514 0400114	4	0.1	6	14	60	6
UXR514 0300240	3	0.2	4.5	40	80	6	UXR514 0400116	4	0.1	6	16	60	6

Zamus Star
E-Star
U-Wing
Zamus Thunder
X-Star
S-Wing
A-Wing
Standard
Copper-Mate
Gra-Mate

▶ 적용 피삭재

○ : 적합 ◎ : 매우 적합

H		P			K	N			M	S
열처리강		탄소강	합금강	프리하트강	주철	동	흑연	알루미늄	스테인리스	내열합금
SKD61 ~HRc55	SKD11 HRc55~	~HB225	HB225 ~325	HRc30~50	~FCD500					
○		○	◎	◎	○					

UXR514 4날 멀티 헬릭스 넥 래디우스 엔드밀

Endmill

종류	품목코드	DC	RE	APMX	LU	OAL	DCONMS	품목코드	DC	RE	APMX	LU	OAL	DCONMS
		날경	Corner R	날장	유효장	전장	자루경		날경	Corner R	날장	유효장	전장	자루경
Zamus Star	UXR514 0400120	4	0.1	6	20	60	6	UXR514 0400526	4	0.5	6	26	65	6
	UXR514 0400126	4	0.1	6	26	65	6	UXR514 0400530	4	0.5	6	30	70	6
	UXR514 0400130	4	0.1	6	30	70	6	UXR514 0400535	4	0.5	6	35	70	6
	UXR514 0400135	4	0.1	6	35	70	6	UXR514 0400540	4	0.5	6	40	80	6
	UXR514 0400140	4	0.1	6	40	80	6	UXR514 0400545	4	0.5	6	45	90	6
E-Star	UXR514 0400145	4	0.1	6	45	90	6	UXR514 0400550	4	0.5	6	50	100	6
	UXR514 0400150	4	0.1	6	50	100	6	UXR514 0401010	4	1	6	10	50	6
	UXR514 0400210	4	0.2	6	10	50	6	UXR514 0401012	4	1	6	12	50	6
U-Wing	UXR514 0400212	4	0.2	6	12	50	6	UXR514 0401014	4	1	6	14	60	6
	UXR514 0400214	4	0.2	6	14	60	6	UXR514 0401016	4	1	6	16	60	6
	UXR514 0400216	4	0.2	6	16	60	6	UXR514 0401020	4	1	6	20	60	6
	UXR514 0400220	4	0.2	6	20	60	6	UXR514 0401026	4	1	6	26	65	6
	UXR514 0400226	4	0.2	6	26	65	6	UXR514 0401030	4	1	6	30	70	6
Zamus Thunder	UXR514 0400230	4	0.2	6	30	70	6	UXR514 0401035	4	1	6	35	70	6
	UXR514 0400235	4	0.2	6	35	70	6	UXR514 0401040	4	1	6	40	80	6
	UXR514 0400240	4	0.2	6	40	80	6	UXR514 0401045	4	1	6	45	90	6
X-Star	UXR514 0400245	4	0.2	6	45	90	6	UXR514 0401050	4	1	6	50	100	6
	UXR514 0400250	4	0.2	6	50	100	6	UXR514 05001	5	0.1	8	15	60	6
	UXR514 0400310	4	0.3	6	10	50	6	UXR514 05002	5	0.2	8	15	60	6
S-Wing	UXR514 0400312	4	0.3	6	12	50	6	UXR514 05003	5	0.3	8	15	60	6
	UXR514 0400314	4	0.3	6	14	60	6	UXR514 05005	5	0.5	8	15	60	6
	UXR514 0400316	4	0.3	6	16	60	6	UXR514 05010	5	1	8	15	60	6
A-Wing	UXR514 0400320	4	0.3	6	20	60	6	UXR514 05015	5	1.5	8	15	60	6
	UXR514 0400326	4	0.3	6	26	65	6	UXR514 05020	5	2	8	15	60	6
	UXR514 0400330	4	0.3	6	30	70	6	UXR514 06001	6	0.1	9	20	60	6
Standard	UXR514 0400335	4	0.3	6	35	70	6	UXR514 06002	6	0.2	9	20	60	6
	UXR514 0400340	4	0.3	6	40	80	6	UXR514 06003	6	0.3	9	20	60	6
	UXR514 0400345	4	0.3	6	45	90	6	UXR514 06003090	6	0.3	15	30	90	6
	UXR514 0400350	4	0.3	6	50	100	6	UXR514 06005	6	0.5	9	20	60	6
	UXR514 0400510	4	0.5	6	10	50	6	UXR514 06005090	6	0.5	15	30	90	6
Copper-Mate	UXR514 0400512	4	0.5	6	12	50	6	UXR514 06010	6	1	9	20	60	6
	UXR514 0400514	4	0.5	6	14	60	6	UXR514 06010090	6	1	15	30	90	6
	UXR514 0400516	4	0.5	6	16	60	6	UXR514 06015	6	1.5	9	20	60	6
Gra-Mate	UXR514 0400520	4	0.5	6	20	60	6	UXR514 06020	6	2	9	20	60	6

▶ 적용 피삭재

○ : 적합 ◎ : 매우 적합

H		P			K	N		M	S	
열처리강		탄소강	합금강	프리하든강	주철	동	흑연	알루미늄	스테인리스	내열합금
SKD61 ~HRc55	SKD11 HRc55~	~HB225	HB225 ~325	HRc30~50	~FCD500					
○		○	◎	◎	○					

UXR514

4날 멀티 헬릭스 넥 래디우스 엔드밀

Endmill

품목코드	DC	RE	APMX	LU	OAL	DCONMS	품목코드	DC	RE	APMX	LU	OAL	DCONMS
	날경	Corner R	날장	유효장	전장	자루경		날경	Corner R	날장	유효장	전장	자루경
UXR514 08001	8	0.1	12	25	70	8	UXR514 10020	10	2	15	30	75	10
UXR514 08002	8	0.2	12	25	70	8	UXR514 12002	12	0.2	18	32	80	12
UXR514 08003	8	0.3	12	25	70	8	UXR514 12003	12	0.3	18	32	80	12
UXR514 08003100	8	0.3	20	35	100	8	UXR514 12003110	12	0.3	30	45	110	12
UXR514 08005	8	0.5	12	25	70	8	UXR514 12005	12	0.5	18	32	80	12
UXR514 08005100	8	0.5	20	35	100	8	UXR514 12005110	12	0.5	30	45	110	12
UXR514 08010	8	1	12	25	70	8	UXR514 12010	12	1	18	32	80	12
UXR514 08010100	8	1	20	35	100	8	UXR514 12010110	12	1	30	45	110	12
UXR514 08015	8	1.5	12	25	70	8	UXR514 12015	12	1.5	18	32	80	12
UXR514 08020	8	2	12	25	70	8	UXR514 12020	12	2	18	32	80	12
UXR514 10001	10	0.1	15	30	75	10	UXR514 16005	16	0.5	20	35	100	16
UXR514 10002	10	0.2	15	30	75	10	UXR514 16005150	16	0.5	35	50	150	16
UXR514 10003	10	0.3	15	30	75	10	UXR514 16010	16	1	20	35	100	16
UXR514 10003100	10	0.3	25	40	100	10	UXR514 16010150	16	1	35	50	150	16
UXR514 10005	10	0.5	15	30	75	10	UXR514 20005	20	0.5	25	40	100	20
UXR514 10005100	10	0.5	25	40	100	10	UXR514 20005150	20	0.5	40	55	150	20
UXR514 10010	10	1	15	30	75	10	UXR514 20010	20	1	25	40	100	20
UXR514 10010100	10	1	25	40	100	10	UXR514 20010150	20	1	40	55	150	20
UXR514 10015	10	1.5	15	30	75	10							

- Zamus Star
- E-Star
- U-Wing
- Zamus Thunder
- X-Star
- S-Wing
- A-Wing
- Standard
- Copper-Mate
- Gra-Mate

▶ 적용 피삭재

○ : 적합 ◎ : 매우 적합

H		P			K	N			M	S
열처리강		탄소강	합금강	프리하든강	주철	동	흑연	알루미늄	스테인리스	내열합금
SKD61 ~HRc55	SKD11 HRc55~	~HB225	HB225 ~325	HRc30~50	~FCD500					
○		○	◎	◎	○					

UDR503

3날 더블 래디우스 엔드밀

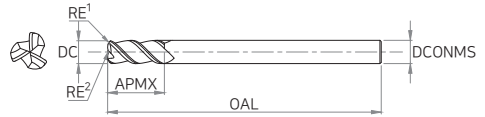

▶ 제품허용공차

날경(DC)		자루경
∅6 ~ ∅20	0 ~ -0.02	h5

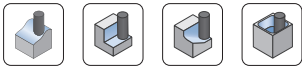

품목코드	DC	RE ¹	RE ²	APMX	OAL	DCONMS
	날경	Corner R	바닥 R	날장	전장	자루경
UDR503 06005	6	0.5	6	10	90	6
UDR503 06010	6	1	6	10	90	6
UDR503 06020	6	2	6	10	90	6
UDR503 08005	8	0.5	8	16	100	8
UDR503 08010	8	1	8	16	100	8
UDR503 08020	8	2	8	16	100	8
UDR503 10005	10	0.5	10	20	100	10
UDR503 10010	10	1	10	20	100	10
UDR503 10020	10	2	10	20	100	10
UDR503 12005	12	0.5	12	24	110	12
UDR503 12010	12	1	12	24	110	12
UDR503 12020	12	2	12	24	110	12
UDR503 16005	16	0.5	16	32	150	16
UDR503 16010	16	1	16	32	150	16
UDR503 20005	20	0.5	20	40	150	20
UDR503 20010	20	1	20	40	150	20

▶ 적용 피삭재

○ : 적합 ◎ : 매우 적합

H		P			K	N			M	S
열처리강		탄소강	합금강	프리하든강	주철	동	흑연	알루미늄	스테인리스	내열합금
SKD61 ~HRc55	SKD11 HRc55~	~HB225	HB225 ~325	HRc30~50	~FCD500					
○		○	◎	◎	○					

USPM4 4날 고이송용 라디우스 엔드밀

Endmill

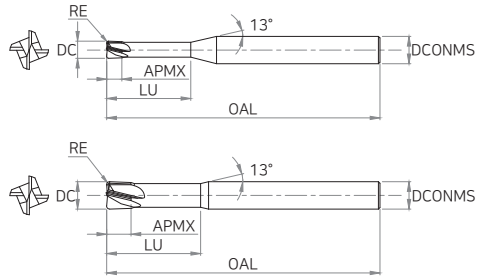

▶ 제품허용공차

날경(DC)		자루경
Ø1 ~ Ø20	0 ~ -0.03	h5

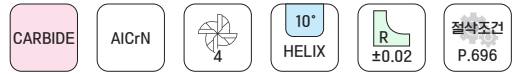
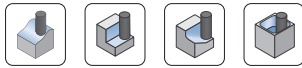

Zamus Star
E-Star
U-Wing

품목코드	DC	RE	APMX	LU	OAL	DCONMS	품목코드	DC	RE	APMX	LU	OAL	DCONMS
	날경	Corner R	날장	유효장	전장	자루경		날경	Corner R	날장	유효장	전장	자루경
USPM4 010-01	1	0.1	1	2.5	50	6	USPM4 060-05	6	0.5	6	15	60	6
USPM4 010-02	1	0.2	1	2.5	50	6	USPM4 060-05L	6	0.5	6	15	90	6
USPM4 010-03	1	0.3	1	2.5	50	6	USPM4 060-10	6	1	6	15	60	6
USPM4 015-02	1.5	0.2	1.5	4	50	6	USPM4 060-10L	6	1	6	15	90	6
USPM4 015-03	1.5	0.3	1.5	4	50	6	USPM4 060-20	6	2	6	15	60	6
USPM4 015-05	1.5	0.5	1.5	4	50	6	USPM4 060-20L	6	2	6	15	90	6
USPM4 020-02	2	0.2	2	6	50	6	USPM4 080-02	8	0.2	8	20	70	8
USPM4 020-03	2	0.3	2	6	50	6	USPM4 080-02L	8	0.2	8	20	100	8
USPM4 020-05	2	0.5	2	6	50	6	USPM4 080-03	8	0.3	8	20	70	8
USPM4 030-02	3	0.2	3	8	50	6	USPM4 080-03L	8	0.3	8	20	100	8
USPM4 030-03	3	0.3	3	8	50	6	USPM4 080-05	8	0.5	8	20	70	8
USPM4 030-05	3	0.5	3	8	50	6	USPM4 080-05L	8	0.5	8	20	100	8
USPM4 040-02	4	0.2	4	10	50	6	USPM4 080-10	8	1	8	20	70	8
USPM4 040-03	4	0.3	4	10	50	6	USPM4 080-10L	8	1	8	20	100	8
USPM4 040-05	4	0.5	4	10	50	6	USPM4 080-20	8	2	8	20	70	8
USPM4 040-10	4	1	4	10	50	6	USPM4 080-20L	8	2	8	20	100	8
USPM4 060-02	6	0.2	6	15	60	6	USPM4 100-02	10	0.2	10	25	75	10
USPM4 060-02L	6	0.2	6	15	90	6	USPM4 100-02L	10	0.2	10	25	100	10
USPM4 060-03	6	0.3	6	15	60	6	USPM4 100-03	10	0.3	10	25	75	10
USPM4 060-03L	6	0.3	6	15	90	6	USPM4 100-03L	10	0.3	10	25	100	10

Zamus Thunder
X-Star
S-Wing
A-Wing
Standard
Copper-Mate
Gra-Mate

▶ 적용 피삭재

○ : 적합 ◎ : 매우 적합

H		P			K	N			M	S
열처리강		탄소강	합금강	프리하든강	주철	동	흑연	알루미늄	스테인리스	내열합금
SKD61 ~HRc55	SKD11 HRc55~	~HB225	HB225 ~325	HRc30~50	~FCD500					
○		○	◎	◎	○					

USPM4 4날 고이송용 래디우스 엔드밀

Endmill

품목코드	DC	RE	APMX	LU	OAL	DCONMS	품목코드	DC	RE	APMX	LU	OAL	DCONMS
	날경	Corner R	날장	유효장	전장	자루경		날경	Corner R	날장	유효장	전장	자루경
USPM4 100-05	10	0.5	10	25	75	10	USPM4 120-20	12	2	12	30	80	12
USPM4 100-05L	10	0.5	10	25	100	10	USPM4 120-20L	12	2	12	30	110	12
USPM4 100-10	10	1	10	25	75	10	USPM4 120-30	12	3	12	30	80	12
USPM4 100-10L	10	1	10	25	100	10	USPM4 120-30L	12	3	12	30	110	12
USPM4 100-15	10	1.5	10	25	75	10	USPM4 160-05	16	0.5	16	35	100	16
USPM4 100-15L	10	1.5	10	25	100	10	USPM4 160-05L	16	0.5	16	35	150	16
USPM4 100-20	10	2	10	25	75	10	USPM4 160-10	16	1	16	35	100	16
USPM4 100-20L	10	2	10	25	100	10	USPM4 160-10L	16	1	16	35	150	16
USPM4 120-03	12	0.3	12	30	80	12	USPM4 160-20	16	2	16	35	100	16
USPM4 120-03L	12	0.3	12	30	110	12	USPM4 160-20L	16	2	16	35	150	16
USPM4 120-05	12	0.5	12	30	80	12	USPM4 200-05	20	0.5	20	40	100	20
USPM4 120-05L	12	0.5	12	30	110	12	USPM4 200-05L	20	0.5	20	40	150	20
USPM4 120-10	12	1	12	30	80	12	USPM4 200-10	20	1	20	40	100	20
USPM4 120-10L	12	1	12	30	110	12	USPM4 200-10L	20	1	20	40	150	20
USPM4 120-15	12	1.5	12	30	80	12	USPM4 200-20	20	2	20	40	100	20
USPM4 120-15L	12	1.5	12	30	110	12	USPM4 200-20L	20	2	20	40	150	20

Zamus Star

E-Star

U-Wing

Zamus Thunder

X-Star

S-Wing

A-Wing

Standard

Copper-Mate

Gra-Mate

▶ 적용 피삭재

○ : 적합 ◎ : 매우 적합

H		P			K	N			M	S
열처리강		탄소강	합금강	프리하든강	주철	동	흑연	알루미늄	스테인리스	내열합금
SKD61 ~HRc55	SKD11 HRc55~	~HB225	HB225 ~325	HRc30~50	~FCD500					
○		○	◎	◎	○					

UTR504 4날 테이퍼 래디우스 엔드밀

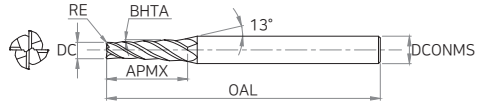

Endmill

▶ 제품허용공차

날경(DC)		자루경
∅0.8 ~ ∅2.5	0 ~ -0.03	h5

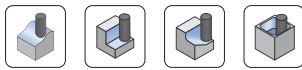

CARBIDE
AlCrN
4
30° HELIX
R ±0.01
절삭조건 P.696

품목코드	DC	RE	APMX	BHTA	OAL	DCONMS	품목코드	DC	RE	APMX	BHTA	OAL	DCONMS
	날경	Corner R	날장	테이퍼각	전장	자루경		날경	Corner R	날장	테이퍼각	전장	자루경
UTR504 008010104	0.8	0.1	4	1	45	4	UTR504 0100101510	1	0.1	10	1.5	50	4
UTR504 008010106	0.8	0.1	6	1	45	4	UTR504 0100101512	1	0.1	12	1.5	50	4
UTR504 008010108	0.8	0.1	8	1	45	4	UTR504 010010204	1	0.1	4	2	50	4
UTR504 0080101504	0.8	0.1	4	1.5	45	4	UTR504 010010206	1	0.1	6	2	50	4
UTR504 0080101506	0.8	0.1	6	1.5	45	4	UTR504 010010208	1	0.1	8	2	50	4
UTR504 0080101508	0.8	0.1	8	1.5	45	4	UTR504 010010210	1	0.1	10	2	50	4
UTR504 008020104	0.8	0.2	4	1	45	4	UTR504 010010212	1	0.1	12	2	50	4
UTR504 008020106	0.8	0.2	6	1	45	4	UTR504 010010304	1	0.1	4	3	50	4
UTR504 008020108	0.8	0.2	8	1	45	4	UTR504 010010306	1	0.1	6	3	50	4
UTR504 0080201504	0.8	0.2	4	1.5	45	4	UTR504 010010308	1	0.1	8	3	50	4
UTR504 0080201506	0.8	0.2	6	1.5	45	4	UTR504 010010310	1	0.1	10	3	50	4
UTR504 0080201508	0.8	0.2	8	1.5	45	4	UTR504 010010312	1	0.1	12	3	50	4
UTR504 010010104	1	0.1	4	1	50	4	UTR504 010020104	1	0.2	4	1	50	4
UTR504 010010106	1	0.1	6	1	50	4	UTR504 010020106	1	0.2	6	1	50	4
UTR504 010010108	1	0.1	8	1	50	4	UTR504 010020108	1	0.2	8	1	50	4
UTR504 010010110	1	0.1	10	1	50	4	UTR504 010020110	1	0.2	10	1	50	4
UTR504 010010112	1	0.1	12	1	50	4	UTR504 010020112	1	0.2	12	1	50	4
UTR504 0100101504	1	0.1	4	1.5	50	4	UTR504 0100201504	1	0.2	4	1.5	50	4
UTR504 0100101506	1	0.1	6	1.5	50	4	UTR504 0100201506	1	0.2	6	1.5	50	4
UTR504 0100101508	1	0.1	8	1.5	50	4	UTR504 0100201508	1	0.2	8	1.5	50	4

Zamus Star

E-Star

U-Wing

Zamus Thunder

X-Star

S-Wing

A-Wing

Standard

Copper-Mate

Gra-Mate

▶ 적용 피삭재

○ : 적합 ◎ : 매우 적합

H		P			K	N		M	S	
열처리강		탄소강	합금강	프리하든강	주철	동	흑연	알루미늄	스테인리스	내열합금
SKD61 ~HRc55	SKD11 HRc55~	~HB225	HB225 ~325	HRc30~50	~FCD500					
○		○	◎	◎	○					

UTR504 4날 테이퍼 래디우스 엔드밀

Endmill

품목코드	DC	RE	APMX	BHTA	OAL	DCONMS	품목코드	DC	RE	APMX	BHTA	OAL	DCONMS
	날경	Corner R	날장	테이퍼각	전장	자루경		날경	Corner R	날장	테이퍼각	전장	자루경
UTR504 0100201510	1	0.2	10	1.5	50	4	UTR504 012010110	1.2	0.1	10	1	50	4
UTR504 0100201512	1	0.2	12	1.5	50	4	UTR504 012010112	1.2	0.1	12	1	50	4
UTR504 010020204	1	0.2	4	2	50	4	UTR504 012010206	1.2	0.1	6	2	50	4
UTR504 010020206	1	0.2	6	2	50	4	UTR504 012010208	1.2	0.1	8	2	50	4
UTR504 010020208	1	0.2	8	2	50	4	UTR504 012010210	1.2	0.1	10	2	50	4
UTR504 010020210	1	0.2	10	2	50	4	UTR504 012010212	1.2	0.1	12	2	50	4
UTR504 010020212	1	0.2	12	2	50	4	UTR504 012010306	1.2	0.1	6	3	50	4
UTR504 010020304	1	0.2	4	3	50	4	UTR504 012010308	1.2	0.1	8	3	50	4
UTR504 010020306	1	0.2	6	3	50	4	UTR504 012010310	1.2	0.1	10	3	50	4
UTR504 010020308	1	0.2	8	3	50	4	UTR504 012010312	1.2	0.1	12	3	50	4
UTR504 010020310	1	0.2	10	3	50	4	UTR504 012020106	1.2	0.2	6	1	50	4
UTR504 010020312	1	0.2	12	3	50	4	UTR504 012020108	1.2	0.2	8	1	50	4
UTR504 010030104	1	0.3	4	1	50	4	UTR504 012020110	1.2	0.2	10	1	50	4
UTR504 010030106	1	0.3	6	1	50	4	UTR504 012020112	1.2	0.2	12	1	50	4
UTR504 010030108	1	0.3	8	1	50	4	UTR504 012020206	1.2	0.2	6	2	50	4
UTR504 010030110	1	0.3	10	1	50	4	UTR504 012020208	1.2	0.2	8	2	50	4
UTR504 010030112	1	0.3	12	1	50	4	UTR504 012020210	1.2	0.2	10	2	50	4
UTR504 0100301504	1	0.3	4	1.5	50	4	UTR504 012020212	1.2	0.2	12	2	50	4
UTR504 0100301506	1	0.3	6	1.5	50	4	UTR504 012020306	1.2	0.2	6	3	50	4
UTR504 0100301508	1	0.3	8	1.5	50	4	UTR504 012020308	1.2	0.2	8	3	50	4
UTR504 0100301510	1	0.3	10	1.5	50	4	UTR504 012020310	1.2	0.2	10	3	50	4
UTR504 0100301512	1	0.3	12	1.5	50	4	UTR504 012020312	1.2	0.2	12	3	50	4
UTR504 010030204	1	0.3	4	2	50	4	UTR504 012030106	1.2	0.3	6	1	50	4
UTR504 010030206	1	0.3	6	2	50	4	UTR504 012030108	1.2	0.3	8	1	50	4
UTR504 010030208	1	0.3	8	2	50	4	UTR504 012030110	1.2	0.3	10	1	50	4
UTR504 010030210	1	0.3	10	2	50	4	UTR504 012030112	1.2	0.3	12	1	50	4
UTR504 010030212	1	0.3	12	2	50	4	UTR504 012030206	1.2	0.3	6	2	50	4
UTR504 010030304	1	0.3	4	3	50	4	UTR504 012030208	1.2	0.3	8	2	50	4
UTR504 010030306	1	0.3	6	3	50	4	UTR504 012030210	1.2	0.3	10	2	50	4
UTR504 010030308	1	0.3	8	3	50	4	UTR504 012030212	1.2	0.3	12	2	50	4
UTR504 010030310	1	0.3	10	3	50	4	UTR504 012030306	1.2	0.3	6	3	50	4
UTR504 010030312	1	0.3	12	3	50	4	UTR504 012030308	1.2	0.3	8	3	50	4
UTR504 012010106	1.2	0.1	6	1	50	4	UTR504 012030310	1.2	0.3	10	3	50	4
UTR504 012010108	1.2	0.1	8	1	50	4	UTR504 012030312	1.2	0.3	12	3	50	4

▶ 적용 피삭재

○ : 적합 ◎ : 매우 적합

H		P			K	N			M	S
열처리강		탄소강	합금강	프리하든강	주철	동	흑연	알루미늄	스테인리스	내열합금
SKD61 ~HRc55	SKD11 HRc55~	~HB225	HB225 ~325	HRc30~50	~FCD500					
○		○	◎	◎	○					

UTR504 4날 테이퍼 래디우스 엔드밀

Endmill

품목코드	DC	RE	APMX	BHTA	OAL	DCONMS	품목코드	DC	RE	APMX	BHTA	OAL	DCONMS
	날경	Corner R	날장	테이퍼각	전장	자루경		날경	Corner R	날장	테이퍼각	전장	자루경
UTR504 015010106	1.5	0.1	6	1	50	4	UTR504 015020316	1.5	0.2	16	3	50	4
UTR504 015010108	1.5	0.1	8	1	50	4	UTR504 015020320	1.5	0.2	20	3	60	4
UTR504 015010110	1.5	0.1	10	1	50	4	UTR504 015030106	1.5	0.3	6	1	50	4
UTR504 015010112	1.5	0.1	12	1	50	4	UTR504 015030108	1.5	0.3	8	1	50	4
UTR504 015010116	1.5	0.1	16	1	50	4	UTR504 015030110	1.5	0.3	10	1	50	4
UTR504 015010120	1.5	0.1	20	1	60	4	UTR504 015030112	1.5	0.3	12	1	50	4
UTR504 015010206	1.5	0.1	6	2	50	4	UTR504 015030116	1.5	0.3	16	1	50	4
UTR504 015010208	1.5	0.1	8	2	50	4	UTR504 015030120	1.5	0.3	20	1	60	4
UTR504 015010210	1.5	0.1	10	2	50	4	UTR504 015030206	1.5	0.3	6	2	50	4
UTR504 015010212	1.5	0.1	12	2	50	4	UTR504 015030208	1.5	0.3	8	2	50	4
UTR504 015010216	1.5	0.1	16	2	50	4	UTR504 015030210	1.5	0.3	10	2	50	4
UTR504 015010220	1.5	0.1	20	2	60	4	UTR504 015030212	1.5	0.3	12	2	50	4
UTR504 015010306	1.5	0.1	6	3	50	4	UTR504 015030216	1.5	0.3	16	2	50	4
UTR504 015010308	1.5	0.1	8	3	50	4	UTR504 015030220	1.5	0.3	20	2	60	4
UTR504 015010310	1.5	0.1	10	3	50	4	UTR504 015030306	1.5	0.3	6	3	50	4
UTR504 015010312	1.5	0.1	12	3	50	4	UTR504 015030308	1.5	0.3	8	3	50	4
UTR504 015010316	1.5	0.1	16	3	50	4	UTR504 015030310	1.5	0.3	10	3	50	4
UTR504 015010320	1.5	0.1	20	3	60	4	UTR504 015030312	1.5	0.3	12	3	50	4
UTR504 015020106	1.5	0.2	6	1	50	4	UTR504 015030316	1.5	0.3	16	3	50	4
UTR504 015020108	1.5	0.2	8	1	50	4	UTR504 015030320	1.5	0.3	20	3	60	4
UTR504 015020110	1.5	0.2	10	1	50	4	UTR504 020010108	2	0.1	8	1	50	4
UTR504 015020112	1.5	0.2	12	1	50	4	UTR504 020010110	2	0.1	10	1	50	4
UTR504 015020116	1.5	0.2	16	1	50	4	UTR504 020010112	2	0.1	12	1	50	4
UTR504 015020120	1.5	0.2	20	1	60	4	UTR504 020010116	2	0.1	16	1	50	4
UTR504 015020206	1.5	0.2	6	2	50	4	UTR504 020010120	2	0.1	20	1	60	4
UTR504 015020208	1.5	0.2	8	2	50	4	UTR504 020010125	2	0.1	25	1	60	4
UTR504 015020210	1.5	0.2	10	2	50	4	UTR504 020010208	2	0.1	8	2	50	4
UTR504 015020212	1.5	0.2	12	2	50	4	UTR504 020010210	2	0.1	10	2	50	4
UTR504 015020216	1.5	0.2	16	2	50	4	UTR504 020010212	2	0.1	12	2	50	4
UTR504 015020220	1.5	0.2	20	2	60	4	UTR504 020010216	2	0.1	16	2	50	4
UTR504 015020306	1.5	0.2	6	3	50	4	UTR504 020010220	2	0.1	20	2	60	4
UTR504 015020308	1.5	0.2	8	3	50	4	UTR504 020010225	2	0.1	25	2	60	4
UTR504 015020310	1.5	0.2	10	3	50	4	UTR504 020010308	2	0.1	8	3	50	4
UTR504 015020312	1.5	0.2	12	3	50	4	UTR504 020010310	2	0.1	10	3	50	4

Zamus Star
E-Star
U-Wing
Zamus Thunder
X-Star
S-Wing
A-Wing
Standard
Copper-Mate
Gra-Mate

▶ 적용 피삭재

○ : 적합 ◎ : 매우 적합

H		P			K	N		M	S	
열처리강		탄소강	합금강	프리하든강	주철	동	흑연	알루미늄	스테인리스	내열합금
SKD61 ~HRc55	SKD11 HRc55~	~HB225	HB225 ~325	HRc30~50	~FCD500					
○		○	◎	◎	○					

UTR504 4날 테이퍼 래디우스 엔드밀

Endmill

품목코드	DC	RE	APMX	BHTA	OAL	DCONMS	품목코드	DC	RE	APMX	BHTA	OAL	DCONMS
	날경	Corner R	날장	테이퍼각	전장	자루경		날경	Corner R	날장	테이퍼각	전장	자루경
UTR504 020010312	2	0.1	12	3	50	4	UTR504 020030308	2	0.3	8	3	50	4
UTR504 020010316	2	0.1	16	3	50	4	UTR504 020030310	2	0.3	10	3	50	4
UTR504 020010320	2	0.1	20	3	60	6	UTR504 020030312	2	0.3	12	3	50	4
UTR504 020010325	2	0.1	25	3	60	6	UTR504 020030316	2	0.3	16	3	50	4
UTR504 020020108	2	0.2	8	1	50	4	UTR504 020030320	2	0.3	20	3	60	6
UTR504 020020110	2	0.2	10	1	50	4	UTR504 020030325	2	0.3	25	3	60	6
UTR504 020020112	2	0.2	12	1	50	4	UTR504 025010110	2.5	0.1	10	1	50	4
UTR504 020020116	2	0.2	16	1	50	4	UTR504 025010112	2.5	0.1	12	1	50	4
UTR504 020020120	2	0.2	20	1	60	4	UTR504 025010116	2.5	0.1	16	1	50	4
UTR504 020020125	2	0.2	25	1	60	4	UTR504 025010120	2.5	0.1	20	1	60	4
UTR504 020020208	2	0.2	8	2	50	4	UTR504 025010125	2.5	0.1	25	1	60	4
UTR504 020020210	2	0.2	10	2	50	4	UTR504 025010130	2.5	0.1	30	1	60	4
UTR504 020020212	2	0.2	12	2	50	4	UTR504 025010210	2.5	0.1	10	2	50	4
UTR504 020020216	2	0.2	16	2	50	4	UTR504 025010212	2.5	0.1	12	2	50	4
UTR504 020020220	2	0.2	20	2	60	4	UTR504 025010216	2.5	0.1	16	2	50	4
UTR504 020020225	2	0.2	25	2	60	4	UTR504 025010220	2.5	0.1	20	2	60	4
UTR504 020020308	2	0.2	8	3	50	4	UTR504 025010225	2.5	0.1	25	2	60	6
UTR504 020020310	2	0.2	10	3	50	4	UTR504 025010230	2.5	0.1	30	2	60	6
UTR504 020020312	2	0.2	12	3	50	4	UTR504 025010310	2.5	0.1	10	3	50	4
UTR504 020020316	2	0.2	16	3	50	4	UTR504 025010312	2.5	0.1	12	3	50	4
UTR504 020020320	2	0.2	20	3	60	6	UTR504 025010316	2.5	0.1	16	3	50	6
UTR504 020020325	2	0.2	25	3	60	6	UTR504 025010320	2.5	0.1	20	3	60	6
UTR504 020030108	2	0.3	8	1	50	4	UTR504 025010325	2.5	0.1	25	3	60	6
UTR504 020030110	2	0.3	10	1	50	4	UTR504 025010330	2.5	0.1	30	3	60	6
UTR504 020030112	2	0.3	12	1	50	4	UTR504 025020110	2.5	0.2	10	1	50	4
UTR504 020030116	2	0.3	16	1	50	4	UTR504 025020112	2.5	0.2	12	1	50	4
UTR504 020030120	2	0.3	20	1	60	4	UTR504 025020116	2.5	0.2	16	1	50	4
UTR504 020030125	2	0.3	25	1	60	4	UTR504 025020120	2.5	0.2	20	1	60	4
UTR504 020030208	2	0.3	8	2	50	4	UTR504 025020125	2.5	0.2	25	1	60	4
UTR504 020030210	2	0.3	10	2	50	4	UTR504 025020130	2.5	0.2	30	1	60	4
UTR504 020030212	2	0.3	12	2	50	4	UTR504 025020210	2.5	0.2	10	2	50	4
UTR504 020030216	2	0.3	16	2	50	4	UTR504 025020212	2.5	0.2	12	2	50	4
UTR504 020030220	2	0.3	20	2	60	4	UTR504 025020216	2.5	0.2	16	2	50	4
UTR504 020030225	2	0.3	25	2	60	4	UTR504 025020220	2.5	0.2	20	2	60	4

▶ 적용 피삭재

○ : 적합 ◎ : 매우 적합

H		P			K	N			M	S
열처리강		탄소강	합금강	프리하든강	주철	동	흑연	알루미늄	스테인리스	내열합금
SKD61 ~HRc55	SKD11 HRc55~	~HB225	HB225 ~325	HRc30~50	~FCD500					
○		○	◎	◎	○					

UTR504

4날 테이퍼 래디우스 엔드밀

Endmill

품목코드	DC	RE	APMX	BHTA	OAL	DCONMS	품목코드	DC	RE	APMX	BHTA	OAL	DCONMS
	날경	Corner R	날장	테이퍼각	전장	자루경		날경	Corner R	날장	테이퍼각	전장	자루경
UTR504 025020225	2.5	0.2	25	2	60	6	UTR504 025030130	2.5	0.3	30	1	60	4
UTR504 025020230	2.5	0.2	30	2	60	6	UTR504 025030210	2.5	0.3	10	2	50	4
UTR504 025020310	2.5	0.2	10	3	50	4	UTR504 025030212	2.5	0.3	12	2	50	4
UTR504 025020312	2.5	0.2	12	3	50	4	UTR504 025030216	2.5	0.3	16	2	50	4
UTR504 025020316	2.5	0.2	16	3	50	6	UTR504 025030220	2.5	0.3	20	2	60	4
UTR504 025020320	2.5	0.2	20	3	60	6	UTR504 025030225	2.5	0.3	25	2	60	6
UTR504 025020325	2.5	0.2	25	3	60	6	UTR504 025030230	2.5	0.3	30	2	60	6
UTR504 025020330	2.5	0.2	30	3	60	6	UTR504 025030310	2.5	0.3	10	3	50	4
UTR504 025030110	2.5	0.3	10	1	50	4	UTR504 025030312	2.5	0.3	12	3	50	4
UTR504 025030112	2.5	0.3	12	1	50	4	UTR504 025030316	2.5	0.3	16	3	50	6
UTR504 025030116	2.5	0.3	16	1	50	4	UTR504 025030320	2.5	0.3	20	3	60	6
UTR504 025030120	2.5	0.3	20	1	60	4	UTR504 025030325	2.5	0.3	25	3	60	6
UTR504 025030125	2.5	0.3	25	1	60	4	UTR504 025030330	2.5	0.3	30	3	60	6

- Zamus Star
- E-Star
- U-Wing
- Zamus Thunder
- X-Star
- S-Wing
- A-Wing
- Standard
- Copper-Mate
- Gra-Mate

▶ 적용 피삭재

○ : 적합 ◎ : 매우 적합

H		P			K	N			M	S
열처리강		탄소강	합금강	프리하든강	주철	동	흑연	알루미늄	스테인리스	내열합금
SKD61 ~HRc55	SKD11 HRc55~	~HB225	HB225 ~325	HRc30~50	~FCD500					
○		○	◎	◎	○					

UB502 2날 볼 엔드밀

Endmill

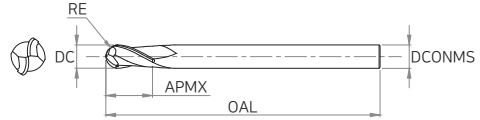
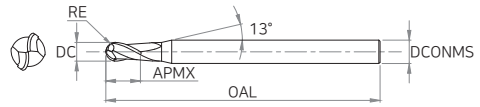

▶ 제품허용공차

날경(DC)		자루경
∅0.1 ~ ∅6	0 ~ -0.012	h5
∅6.5 ~ ∅25	0 ~ -0.015	



CARBIDE
AiCrN
2
30° HELIX
R ±0.005 R3 이하
R ±0.01 R3 초과
절삭조건 P.697

품목코드	DC	RE	APMX	OAL	DCONMS	품목코드	DC	RE	APMX	OAL	DCONMS
	날경	반경 R	날장	전장	자루경		날경	반경 R	날장	전장	자루경
UB502 001S	0.1	0.05	0.1	40	4	UB502 006S3	0.6	0.3	1.2	40	3
UB502 001	0.1	0.05	0.2	40	4	UB502 007S	0.7	0.35	0.7	40	4
UB502 001S3	0.1	0.05	0.2	40	3	UB502 007	0.7	0.35	1.4	40	4
UB502 0015S	0.15	0.075	0.15	40	4	UB502 007S3	0.7	0.35	1.4	40	3
UB502 0015	0.15	0.075	0.3	40	4	UB502 008S	0.8	0.4	0.8	40	4
UB502 0015S3	0.15	0.075	0.3	40	3	UB502 008	0.8	0.4	1.6	40	4
UB502 002S	0.2	0.1	0.2	40	4	UB502 008S3	0.8	0.4	1.6	40	3
UB502 002	0.2	0.1	0.4	40	4	UB502 009S	0.9	0.45	0.9	40	4
UB502 002S3	0.2	0.1	0.4	40	3	UB502 009	0.9	0.45	1.8	40	4
UB502 003S	0.3	0.15	0.3	40	4	UB502 009S3	0.9	0.45	1.8	40	3
UB502 003	0.3	0.15	0.6	40	4	UB502 010S	1	0.5	1.5	40	6
UB502 003S3	0.3	0.15	0.6	40	3	UB502 010S3	1	0.5	2.5	50	3
UB502 004S	0.4	0.2	0.4	40	4	UB502 010S4	1	0.5	2.5	50	4
UB502 004	0.4	0.2	0.8	40	4	UB502 010	1	0.5	2.5	50	6
UB502 004S3	0.4	0.2	0.8	40	3	UB502 010070	1	0.5	2.5	70	6
UB502 005S	0.5	0.25	0.5	40	4	UB502 010100	1	0.5	2.5	100	6
UB502 005	0.5	0.25	1	40	4	UB502 012S	1.2	0.6	2	40	6
UB502 005S3	0.5	0.25	1	40	3	UB502 012S3	1.2	0.6	3	50	3
UB502 006S	0.6	0.3	0.6	40	4	UB502 012S4	1.2	0.6	3	50	4
UB502 006	0.6	0.3	1.2	40	4	UB502 012	1.2	0.6	3	50	6

▶ 적용 피삭재

○ : 적합 ◎ : 매우 적합

H		P			K	N			M	S
열처리강		탄소강	합금강	프리하든강	주철	동	흑연	알루미늄	스테인리스	내열합금
SKD61 ~HRc55	SKD11 HRc55~	~HB225	HB225 ~325	HRc30~50	~FCD500					
○		○	◎	◎	○					

UB502 2날 블 엔드밀

Endmill

품목코드	DC	RE	APMX	OAL	DCONMS	품목코드	DC	RE	APMX	OAL	DCONMS
	날경	반경 R	날장	전장	자루경		날경	반경 R	날장	전장	자루경
UB502 012070	1.2	0.6	3	70	6	UB502 045	4.5	2.25	9	80	6
UB502 012100	1.2	0.6	3	100	6	UB502 050S	5	2.5	7.5	60	6
UB502 015S	1.5	0.75	2.5	40	6	UB502 050	5	2.5	10	80	6
UB502 015S3	1.5	0.75	4	50	3	UB502 050S5	5	2.5	10	80	5
UB502 015S4	1.5	0.75	4	50	4	UB502 055	5.5	2.75	11	90	6
UB502 015	1.5	0.75	4	50	6	UB502 060S	6	3	9	50	6
UB502 015070	1.5	0.75	4	70	6	UB502 060060	6	3	9	60	6
UB502 015100	1.5	0.75	4	100	6	UB502 060080	6	3	9	80	6
UB502 020S	2	1	3	40	6	UB502 060	6	3	12	90	6
UB502 020S3	2	1	5	50	3	UB502 060110	6	3	12	110	6
UB502 020S4	2	1	5	50	4	UB502 060130	6	3	12	130	6
UB502 020	2	1	5	50	6	UB502 060150	6	3	12	150	6
UB502 020080	2	1	5	80	6	UB502 065	6.5	3.25	13	90	8
UB502 020100	2	1	5	100	6	UB502 070	7	3.5	14	90	8
UB502 025S	2.5	1.25	4	40	6	UB502 080S	8	4	12	50	8
UB502 025S3	2.5	1.25	6	60	3	UB502 080060	8	4	12	60	8
UB502 025S4	2.5	1.25	6	60	4	UB502 080080	8	4	12	80	8
UB502 025	2.5	1.25	6	60	6	UB502 080090	8	4	12	90	8
UB502 025080	2.5	1.25	6	80	6	UB502 080	8	4	14	100	8
UB502 025100	2.5	1.25	6	100	6	UB502 080130	8	4	14	130	8
UB502 030S	3	1.5	4.5	40	6	UB502 080150	8	4	14	150	8
UB502 030S3	3	1.5	6	60	3	UB502 085	8.5	4.25	16	100	10
UB502 030S4	3	1.5	6	60	4	UB502 090	9	4.5	18	100	10
UB502 030	3	1.5	6	60	6	UB502 100S	10	5	15	50	10
UB502 030080	3	1.5	6	80	6	UB502 100060	10	5	15	60	10
UB502 030100	3	1.5	6	100	6	UB502 100080	10	5	15	80	10
UB502 035	3.5	1.75	8	70	6	UB502 100090	10	5	15	90	10
UB502 040S	4	2	6	50	6	UB502 100	10	5	18	100	10
UB502 040S4	4	2	8	70	4	UB502 100130	10	5	18	130	10
UB502 040	4	2	8	70	6	UB502 100150	10	5	18	150	10
UB502 040100S4	4	2	8	100	4	UB502 100180	10	5	18	180	10
UB502 040120S4	4	2	8	120	4	UB502 100200	10	5	18	200	10
UB502 040100	4	2	8	100	6	UB502 110	11	5.5	20	100	12
UB502 040120	4	2	8	120	6	UB502 120S	12	6	18	60	12

Zamus Star
E-Star
U-Wing
Zamus Thunder
X-Star
S-Wing
A-Wing
Standard
Copper-Mate
Gra-Mate

▶ 적용 피삭재

○ : 적합 ◎ : 매우 적합

H		P			K	N			M	S
열처리강		탄소강	합금강	프리하든강	주철	동	흑연	알루미늄	스테인리스	내열합금
SKD61 ~HRC55	SKD11 HRC55~	~HB225	HB225 ~325	HRC30~50	~FCD500					
○		○	◎	◎	○					

UB502 2날 볼 엔드밀

Endmill

Zamus Star

E-Star

U-Wing

Zamus Thunder

X-Star

S-Wing

A-Wing

Standard

Copper-Mate

Gra-Mate

품목코드	DC	RE	APMX	OAL	DCONMS	품목코드	DC	RE	APMX	OAL	DCONMS
	날경	반경 R	날장	전장	자루경		날경	반경 R	날장	전장	자루경
UB502 120080	12	6	18	80	12	UB502 160100	16	8	24	100	16
UB502 120090	12	6	18	90	12	UB502 160130	16	8	24	130	16
UB502 120100	12	6	18	100	12	UB502 160	16	8	30	150	16
UB502 120	12	6	24	110	12	UB502 160180	16	8	30	180	16
UB502 120130	12	6	24	130	12	UB502 160200	16	8	30	200	16
UB502 120150	12	6	24	150	12	UB502 180S16	18	9	34	150	16
UB502 120180	12	6	24	180	12	UB502 180	18	9	34	150	18
UB502 120200	12	6	24	200	12	UB502 200100	20	10	30	100	20
UB502 130	13	6.5	24	100	12	UB502 200130	20	10	30	130	20
UB502 140S12	14	7	26	100	12	UB502 200	20	10	38	150	20
UB502 140	14	7	26	100	14	UB502 200200	20	10	38	200	20
UB502 140S16	14	7	26	100	16	UB502 250120	25	12.5	50	120	25
UB502 150	15	7.5	28	140	16	UB502 250180	25	12.5	50	180	25

▶ 적용 피삭재

○ : 적합 ◎ : 매우 적합

H		P			K	N			M	S
열처리강		탄소강	합금강	프리하든강	주철	동	흑연	알루미늄	스테인리스	내열합금
SKD61 ~HRc55	SKD11 HRc55~	~HB225	HB225 ~325	HRc30~50	~FCD500					
○		○	◎	◎	○					

UB502-P

2날 고정밀 볼 엔드밀

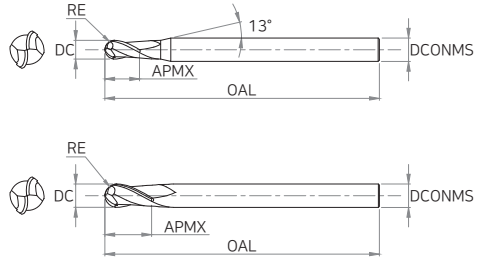

▶ 제품허용공차

날경(DC)		자루경
∅0.1 ~ ∅6	0 ~ -0.012	h5
∅8 ~ ∅12	0 ~ -0.015	



CARBIDE
AlCrN
2
30° HELIX
R ±0.002 R3 이하
R ±0.003 R3 초과
절삭조건 P.697

품목코드	DC 날경	RE 반경 R	APMX 날장	OAL 전장	DCONMS 자루경
UB502 001P	0.1	0.05	0.2	40	4
UB502 0015P	0.15	0.075	0.3	40	4
UB502 002P	0.2	0.1	0.4	40	4
UB502 003P	0.3	0.15	0.6	40	4
UB502 004P	0.4	0.2	0.8	40	4
UB502 005P	0.5	0.25	1	40	4
UB502 006P	0.6	0.3	1.2	40	4
UB502 007P	0.7	0.35	1.4	40	4
UB502 008P	0.8	0.4	1.6	40	4
UB502 009P	0.9	0.45	1.8	40	4
UB502 010P	1	0.5	2.5	50	6

품목코드	DC 날경	RE 반경 R	APMX 날장	OAL 전장	DCONMS 자루경
UB502 012P	1.2	0.6	3	50	6
UB502 015P	1.5	0.75	4	50	6
UB502 020P	2	1	5	50	6
UB502 025P	2.5	1.25	6	60	6
UB502 030P	3	1.5	6	60	6
UB502 040P	4	2	8	70	6
UB502 050P	5	2.5	10	80	6
UB502 060P	6	3	12	90	6
UB502 080P	8	4	14	100	8
UB502 100P	10	5	18	100	10
UB502 120P	12	6	24	110	12

▶ 적용 피삭재

○ : 적합 ◎ : 매우 적합

H		P			K	N			M	S
열처리강		탄소강	합금강	프리하든강	주철	동	흑연	알루미늄	스테인리스	내열합금
SKD61 ~HRc55	SKD11 HRc55~	~HB225	HB225 ~325	HRc30~50	~FCD500					
○		○	◎	◎	○					

UB503 3날 볼 엔드밀

Endmill

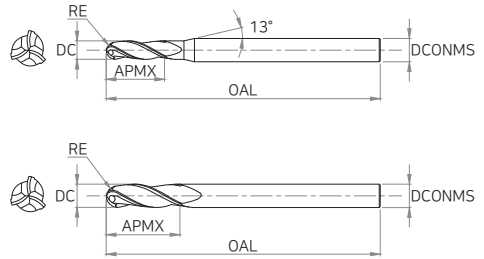

▶ 제품허용공차

날경(DC)		자루경
Ø1 ~ Ø12	0 ~ -0.02	h5



CARBIDE
AlCrN
3
30° HELIX
R ±0.005 R3 이하
R ±0.01 R3 초과
절삭조건 P.698

품목코드	DC	RE	APMX	OAL	DCONMS
	날경	반경 R	날장	전장	자루경
UB503 010	1	0.5	1	50	6
UB503 015	1.5	0.75	1.5	50	6
UB503 020	2	1	2	50	6
UB503 030	3	1.5	3	60	6
UB503 040	4	2	4	70	6
UB503 050	5	2.5	5	80	6
UB503 060	6	3	6	90	6
UB503 080	8	4	8	100	8
UB503 100	10	5	10	100	10
UB503 120	12	6	12	110	12

▶ 적용 피삭재

○ : 적합 ◎ : 매우 적합

H		P			K	N			M	S
열처리강		탄소강	합금강	프리하든강	주철	동	흑연	알루미늄	스테인리스	내열합금
SKD61 ~HRc55	SKD11 HRc55~	~HB225	HB225 ~325	HRc30~50	~FCD500					
○		○	◎	◎	○					

UB504 4날 블 엔드밀

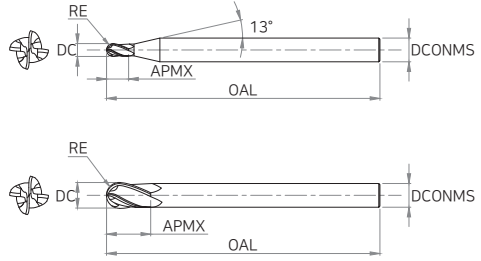

▶ 제품허용공차

날경(DC)		자루경
∅1 ~ ∅12	0 ~ -0.02	h5



CARBIDE
AlCrN
4
30° HELIX
R ±0.005 R3 이하
R ±0.01 R3 초과
절삭조건 P.698

품목코드	DC	RE	APMX	OAL	DCONMS
	날경	반경 R	날장	전장	자루경
UB504 010	1	0.5	1	50	6
UB504 015	1.5	0.75	1.5	50	6
UB504 020	2	1	2	50	6
UB504 030	3	1.5	3	60	6
UB504 040	4	2	4	70	6
UB504 050	5	2.5	5	80	6
UB504 060	6	3	6	90	6
UB504 080	8	4	8	100	8
UB504 100	10	5	10	100	10
UB504 120	12	6	12	110	12

▶ 적용 피삭재

○ : 적합 ◎ : 매우 적합

H		P			K	N			M	S
열처리강		탄소강	합금강	프리하트강	주철	동	흑연	알루미늄	스테인리스	내열합금
SKD61 ~HRc55	SKD11 HRc55~	~HB225	HB225 ~325	HRc30~50	~FCD500					
○		○	◎	◎	○					

UB512 2날 롱 넥 볼 엔드밀

Endmill

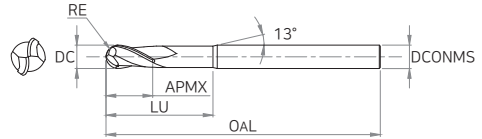
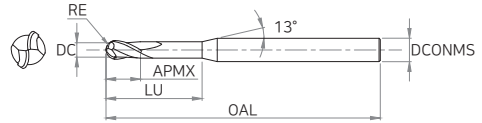

▶ 제품허용공차

날경(DC)		자루경
∅0.1 ~ ∅6	0 ~ -0.012	h5
∅8 ~ ∅12	0 ~ -0.015	

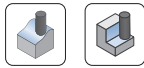

CARBIDE
AiCrN
2
30° HELIX
R ±0.005 R3 이하
R ±0.01 R3 초과
절삭조건 P.699

품목코드	DC	RE	APMX	LU	OAL	DCONMS	품목코드	DC	RE	APMX	LU	OAL	DCONMS
	날경	반경 R	날장	유효장	전장	자루경		날경	반경 R	날장	유효장	전장	자루경
UB512 001002	0.1	0.05	0.1	0.2	40	4	UB512 00403	0.4	0.2	0.4	3	40	4
UB512 001003	0.1	0.05	0.1	0.3	40	4	UB512 00404	0.4	0.2	0.4	4	40	4
UB512 001005	0.1	0.05	0.1	0.5	40	4	UB512 00405	0.4	0.2	0.4	5	40	4
UB512 00101	0.1	0.05	0.1	1	40	4	UB512 00406	0.4	0.2	0.4	6	40	4
UB512 002005	0.2	0.1	0.2	0.5	40	4	UB512 00408	0.4	0.2	0.4	8	40	4
UB512 00201	0.2	0.1	0.2	1	40	4	UB512 00410	0.4	0.2	0.4	10	40	4
UB512 002015	0.2	0.1	0.2	1.5	40	4	UB512 00501	0.5	0.25	0.5	1	45	4
UB512 00202	0.2	0.1	0.2	2	40	4	UB512 005015	0.5	0.25	0.5	1.5	45	4
UB512 00203	0.2	0.1	0.2	3	40	4	UB512 00502	0.5	0.25	0.5	2	45	4
UB512 00301	0.3	0.15	0.3	1	40	4	UB512 005025	0.5	0.25	0.5	2.5	45	4
UB512 003015	0.3	0.15	0.3	1.5	40	4	UB512 00503	0.5	0.25	0.5	3	45	4
UB512 00302	0.3	0.15	0.3	2	40	4	UB512 00504	0.5	0.25	0.5	4	45	4
UB512 003025	0.3	0.15	0.3	2.5	40	4	UB512 00505	0.5	0.25	0.5	5	45	4
UB512 00303	0.3	0.15	0.3	3	40	4	UB512 00506	0.5	0.25	0.5	6	45	4
UB512 00304	0.3	0.15	0.3	4	40	4	UB512 00508	0.5	0.25	0.5	8	45	4
UB512 00305	0.3	0.15	0.3	5	40	4	UB512 00510	0.5	0.25	0.5	10	45	4
UB512 00401	0.4	0.2	0.4	1	40	4	UB512 00512	0.5	0.25	0.5	12	45	4
UB512 004015	0.4	0.2	0.4	1.5	40	4	UB512 00514	0.5	0.25	0.5	14	45	4
UB512 00402	0.4	0.2	0.4	2	40	4	UB512 00516	0.5	0.25	0.5	16	45	4
UB512 004025	0.4	0.2	0.4	2.5	40	4	UB512 00601	0.6	0.3	0.6	1	45	4

▶ 적용 피삭재

○ : 적합 ◎ : 매우 적합

H		P			K	N			M	S
열처리강		탄소강	합금강	프리하든강	주철	동	흑연	알루미늄	스테인리스	내열합금
SKD61 ~HRc55	SKD11 HRc55~	~HB225	HB225 ~325	HRC30~50	~FCD500					
○		○	◎	◎	○					

UB512 2날 롱 넥 블 엔드밀

Endmill

품목코드	DC	RE	APMX	LU	OAL	DCONMS	품목코드	DC	RE	APMX	LU	OAL	DCONMS
	날경	반경 R	날장	유효장	전장	자루경		날경	반경 R	날장	유효장	전장	자루경
UB512 00602	0.6	0.3	0.6	2	45	4	UB512 010025	1	0.5	1	2.5	50	4
UB512 00603	0.6	0.3	0.6	3	45	4	UB512 01003	1	0.5	1	3	50	4
UB512 00604	0.6	0.3	0.6	4	45	4	UB512 01004	1	0.5	1	4	50	4
UB512 00605	0.6	0.3	0.6	5	45	4	UB512 01005	1	0.5	1	5	50	4
UB512 00606	0.6	0.3	0.6	6	45	4	UB512 01006	1	0.5	1	6	50	4
UB512 00608	0.6	0.3	0.6	8	45	4	UB512 01007	1	0.5	1	7	50	4
UB512 00610	0.6	0.3	0.6	10	45	4	UB512 01008	1	0.5	1	8	50	4
UB512 00612	0.6	0.3	0.6	12	45	4	UB512 01009	1	0.5	1	9	50	4
UB512 00614	0.6	0.3	0.6	14	45	4	UB512 01010	1	0.5	1	10	50	4
UB512 00616	0.6	0.3	0.6	16	45	4	UB512 01012	1	0.5	1	12	50	4
UB512 00702	0.7	0.35	0.7	2	45	4	UB512 01014	1	0.5	1	14	50	4
UB512 00704	0.7	0.35	0.7	4	45	4	UB512 01016	1	0.5	1	16	50	4
UB512 00706	0.7	0.35	0.7	6	45	4	UB512 01018	1	0.5	1	18	50	4
UB512 00708	0.7	0.35	0.7	8	45	4	UB512 01020	1	0.5	1	20	55	4
UB512 00710	0.7	0.35	0.7	10	45	4	UB512 01022	1	0.5	1	22	60	4
UB512 00712	0.7	0.35	0.7	12	45	4	UB512 01026	1	0.5	1	26	60	4
UB512 00801	0.8	0.4	0.8	1	45	4	UB512 01030	1	0.5	1	30	70	4
UB512 00802	0.8	0.4	0.8	2	45	4	UB512 01040	1	0.5	1	40	80	4
UB512 00803	0.8	0.4	0.8	3	45	4	UB512 01050	1	0.5	1	50	100	4
UB512 00804	0.8	0.4	0.8	4	45	4	UB512 01204	1.2	0.6	1.2	4	50	4
UB512 00805	0.8	0.4	0.8	5	45	4	UB512 01206	1.2	0.6	1.2	6	50	4
UB512 00806	0.8	0.4	0.8	6	45	4	UB512 01208	1.2	0.6	1.2	8	50	4
UB512 00807	0.8	0.4	0.8	7	45	4	UB512 01210	1.2	0.6	1.2	10	50	4
UB512 00808	0.8	0.4	0.8	8	45	4	UB512 01212	1.2	0.6	1.2	12	50	4
UB512 00810	0.8	0.4	0.8	10	45	4	UB512 01214	1.2	0.6	1.2	14	50	4
UB512 00812	0.8	0.4	0.8	12	45	4	UB512 01216	1.2	0.6	1.2	16	50	4
UB512 00814	0.8	0.4	0.8	14	45	4	UB512 01220	1.2	0.6	1.2	20	55	4
UB512 00816	0.8	0.4	0.8	16	45	4	UB512 01226	1.2	0.6	1.2	26	60	4
UB512 00820	0.8	0.4	0.8	20	45	4	UB512 01406	1.4	0.7	1.4	6	50	4
UB512 00904	0.9	0.45	0.9	4	45	4	UB512 01408	1.4	0.7	1.4	8	50	4
UB512 00906	0.9	0.45	0.9	6	45	4	UB512 01410	1.4	0.7	1.4	10	50	4
UB512 00908	0.9	0.45	0.9	8	45	4	UB512 01412	1.4	0.7	1.4	12	50	4
UB512 00910	0.9	0.45	0.9	10	45	4	UB512 01416	1.4	0.7	1.4	16	50	4
UB512 01002	1	0.5	1	2	50	4	UB512 01503	1.5	0.75	1.5	3	50	4

Zamus Star
E-Star
U-Wing
Zamus Thunder
X-Star
S-Wing
A-Wing
Standard
Copper-Mate
Gra-Mate

▶ 적용 피삭재

○ : 적합 ◎ : 매우 적합

H		P			K	N			M	S
열처리강		탄소강	합금강	프리하트강	주철	동	흑연	알루미늄	스테인리스	내열합금
SKD61 ~HRc55	SKD11 HRc55~	~HB225	HB225 ~325	HRc30~50	~FCD500					
○		○	◎	◎	○					

UB512 2날 롱 넥 볼 엔드밀

Endmill

품목코드	DC	RE	APMX	LU	OAL	DCONMS	품목코드	DC	RE	APMX	LU	OAL	DCONMS
	날경	반경 R	날장	유효장	전장	자루경		날경	반경 R	날장	유효장	전장	자루경
UB512 01504	1.5	0.75	1.5	4	50	4	UB512 02010	2	1	2	10	50	4
UB512 01505	1.5	0.75	1.5	5	50	4	UB512 02012	2	1	2	12	50	4
UB512 01506	1.5	0.75	1.5	6	50	4	UB512 02014	2	1	2	14	50	4
UB512 01507	1.5	0.75	1.5	7	50	4	UB512 02016	2	1	2	16	50	4
UB512 01508	1.5	0.75	1.5	8	50	4	UB512 02018	2	1	2	18	55	4
UB512 01510	1.5	0.75	1.5	10	50	4	UB512 02020	2	1	2	20	55	4
UB512 01512	1.5	0.75	1.5	12	50	4	UB512 02022	2	1	2	22	60	4
UB512 01514	1.5	0.75	1.5	14	50	4	UB512 02026	2	1	2	26	60	4
UB512 01516	1.5	0.75	1.5	16	50	4	UB512 02030	2	1	2	30	70	4
UB512 01518	1.5	0.75	1.5	18	50	4	UB512 02035	2	1	2	35	70	4
UB512 01520	1.5	0.75	1.5	20	55	4	UB512 02040	2	1	2	40	80	4
UB512 01522	1.5	0.75	1.5	22	60	4	UB512 02045	2	1	2	45	90	4
UB512 01526	1.5	0.75	1.5	26	60	4	UB512 02050	2	1	2	50	100	4
UB512 01530	1.5	0.75	1.5	30	70	4	UB512 02060	2	1	2	60	110	4
UB512 01535	1.5	0.75	1.5	35	70	4	UB512 02508	2.5	1.25	2.5	8	50	4
UB512 01540	1.5	0.75	1.5	40	80	4	UB512 02510	2.5	1.25	2.5	10	50	4
UB512 01604	1.6	0.8	1.6	4	50	4	UB512 02512	2.5	1.25	2.5	12	50	4
UB512 01606	1.6	0.8	1.6	6	50	4	UB512 02516	2.5	1.25	2.5	16	50	4
UB512 01608	1.6	0.8	1.6	8	50	4	UB512 02520	2.5	1.25	2.5	20	50	4
UB512 01610	1.6	0.8	1.6	10	50	4	UB512 02522	2.5	1.25	2.5	22	60	4
UB512 01612	1.6	0.8	1.6	12	50	4	UB512 02526	2.5	1.25	2.5	26	60	4
UB512 01616	1.6	0.8	1.6	16	50	4	UB512 02530	2.5	1.25	2.5	30	70	4
UB512 01620	1.6	0.8	1.6	20	50	4	UB512 02535	2.5	1.25	2.5	35	70	4
UB512 01804	1.8	0.9	1.8	4	50	4	UB512 02540	2.5	1.25	2.5	40	80	4
UB512 01806	1.8	0.9	1.8	6	50	4	UB512 02545	2.5	1.25	2.5	45	90	4
UB512 01808	1.8	0.9	1.8	8	50	4	UB512 02550	2.5	1.25	2.5	50	100	4
UB512 01810	1.8	0.9	1.8	10	50	4	UB512 03006	3	1.5	3	6	50	6
UB512 01812	1.8	0.9	1.8	12	50	4	UB512 03008	3	1.5	3	8	50	6
UB512 01816	1.8	0.9	1.8	16	50	4	UB512 03010	3	1.5	3	10	50	6
UB512 01820	1.8	0.9	1.8	20	50	4	UB512 03012	3	1.5	3	12	50	6
UB512 02004	2	1	2	4	50	4	UB512 03014	3	1.5	3	14	60	6
UB512 02005	2	1	2	5	50	4	UB512 03016	3	1.5	3	16	60	6
UB512 02006	2	1	2	6	50	4	UB512 03018	3	1.5	3	18	60	6
UB512 02008	2	1	2	8	50	4	UB512 03020	3	1.5	3	20	60	6

▶ 적용 피삭재

○ : 적합 ◎ : 매우 적합

H		P			K	N			M	S
열처리강		탄소강	합금강	프리하든강	주철	동	흑연	알루미늄	스테인리스	내열합금
SKD61 ~HRc55	SKD11 HRc55~	~HB225	HB225 ~325	HRc30~50	~FCD500					
○		○	◎	◎	○					

UB512 2날 롱 넥 블 엔드밀

Endmill

품목코드	DC	RE	APMX	LU	OAL	DCONMS	품목코드	DC	RE	APMX	LU	OAL	DCONMS
	날경	반경 R	날장	유효장	전장	자루경		날경	반경 R	날장	유효장	전장	자루경
UB512 03022	3	1.5	3	22	65	6	UB512 05020	5	2.5	6	20	60	6
UB512 03026	3	1.5	3	26	65	6	UB512 05026	5	2.5	6	26	65	6
UB512 03030	3	1.5	3	30	70	6	UB512 05030	5	2.5	6	30	70	6
UB512 03035	3	1.5	3	35	70	6	UB512 05035	5	2.5	6	35	70	6
UB512 03040	3	1.5	3	40	80	6	UB512 05040	5	2.5	6	40	80	6
UB512 03045	3	1.5	3	45	90	6	UB512 05045	5	2.5	6	45	90	6
UB512 03050	3	1.5	3	50	100	6	UB512 05050	5	2.5	6	50	100	6
UB512 03060	3	1.5	3	60	100	6	UB512 05055	5	2.5	6	55	100	6
UB512 04008	4	2	4	8	50	6	UB512 05060	5	2.5	6	60	100	6
UB512 04010	4	2	4	10	50	6	UB512 06020	6	3	8	20	60	6
UB512 04012	4	2	4	12	50	6	UB512 0602090	6	3	12	20	90	6
UB512 04014	4	2	4	14	60	6	UB512 06030	6	3	8	30	60	6
UB512 04016	4	2	4	16	60	6	UB512 0603090	6	3	12	30	90	6
UB512 04018	4	2	4	18	60	6	UB512 08025	8	4	10	25	70	8
UB512 04020	4	2	4	20	60	6	UB512 08025100	8	4	14	25	100	8
UB512 04022	4	2	4	22	65	6	UB512 08035	8	4	10	35	70	8
UB512 04026	4	2	4	26	65	6	UB512 08035100	8	4	14	35	100	8
UB512 04030	4	2	4	30	70	6	UB512 10030	10	5	12	30	75	10
UB512 04035	4	2	4	35	70	6	UB512 10030100	10	5	18	30	100	10
UB512 04040	4	2	4	40	80	6	UB512 10040	10	5	12	40	75	10
UB512 04045	4	2	4	45	90	6	UB512 10040100	10	5	18	40	100	10
UB512 04050	4	2	4	50	100	6	UB512 12032	12	6	14	32	80	12
UB512 04055	4	2	4	55	100	6	UB512 12032110	12	6	22	32	110	12
UB512 04060	4	2	4	60	100	6	UB512 12045	12	6	14	45	80	12
UB512 05015	5	2.5	6	15	60	6	UB512 12045110	12	6	22	45	110	12

Zamus Star
E-Star
U-Wing
Zamus Thunder
X-Star
S-Wing
A-Wing
Standard
Copper-Mate
Gra-Mate

▶ 적용 피삭재

○ : 적합 ◎ : 매우 적합

H		P			K	N			M	S
열처리강		탄소강	합금강	프리하트강	주철	동	흑연	알루미늄	스테인리스	내열합금
SKD61 ~HRc55	SKD11 HRc55~	~HB225	HB225 ~325	HRc30~50	~FCD500					
○		○	◎	◎	○					

UB512 S6 2날 롱 넥 볼 엔드밀(자루경 6)

Endmill

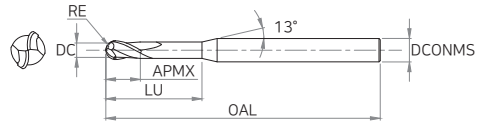

Zamus Star

E-Star

▶ 제품허용공차

날경(DC)		자루경
∅0.5 ~ ∅2	0 ~ -0.012	h5

U-Wing



Zamus Thunder

X-Star

S-Wing

A-Wing

Standard

Copper-Mate

Gra-Mate

품목코드	DC	RE	APMX	LU	OAL	DCONMS	품목코드	DC	RE	APMX	LU	OAL	DCONMS
	날경	반경 R	날장	유효장	전장	자루경		날경	반경 R	날장	유효장	전장	자루경
UB512 00501S6	0.5	0.25	0.5	1	45	6	UB512 00808S6	0.8	0.4	0.8	8	45	6
UB512 00502S6	0.5	0.25	0.5	2	45	6	UB512 00810S6	0.8	0.4	0.8	10	45	6
UB512 00504S6	0.5	0.25	0.5	4	45	6	UB512 00812S6	0.8	0.4	0.8	12	45	6
UB512 00601S6	0.6	0.3	0.6	1	45	6	UB512 00814S6	0.8	0.4	0.8	14	45	6
UB512 00602S6	0.6	0.3	0.6	2	45	6	UB512 00816S6	0.8	0.4	0.8	16	45	6
UB512 00603S6	0.6	0.3	0.6	3	45	6	UB512 00820S6	0.8	0.4	0.8	20	55	6
UB512 00604S6	0.6	0.3	0.6	4	45	6	UB512 01002S6	1	0.5	1	2	50	6
UB512 00605S6	0.6	0.3	0.6	5	45	6	UB512 01003S6	1	0.5	1	3	50	6
UB512 00606S6	0.6	0.3	0.6	6	45	6	UB512 01004S6	1	0.5	1	4	50	6
UB512 00608S6	0.6	0.3	0.6	8	45	6	UB512 01005S6	1	0.5	1	5	50	6
UB512 00610S6	0.6	0.3	0.6	10	45	6	UB512 01006S6	1	0.5	1	6	50	6
UB512 00612S6	0.6	0.3	0.6	12	45	6	UB512 01007S6	1	0.5	1	7	50	6
UB512 00614S6	0.6	0.3	0.6	14	45	6	UB512 01008S6	1	0.5	1	8	50	6
UB512 00616S6	0.6	0.3	0.6	16	45	6	UB512 01009S6	1	0.5	1	9	50	6
UB512 00801S6	0.8	0.4	0.8	1	45	6	UB512 01010S6	1	0.5	1	10	50	6
UB512 00802S6	0.8	0.4	0.8	2	45	6	UB512 01012S6	1	0.5	1	12	50	6
UB512 00803S6	0.8	0.4	0.8	3	45	6	UB512 01014S6	1	0.5	1	14	50	6
UB512 00804S6	0.8	0.4	0.8	4	45	6	UB512 01016S6	1	0.5	1	16	50	6
UB512 00805S6	0.8	0.4	0.8	5	45	6	UB512 01018S6	1	0.5	1	18	50	6
UB512 00806S6	0.8	0.4	0.8	6	45	6	UB512 01020S6	1	0.5	1	20	55	6

▶ 적용 피삭재

○ : 적함 ◎ : 매우 적함

H		P			K	N			M	S
열처리강		탄소강	합금강	프리하든강	주철	동	흑연	알루미늄	스테인리스	내열합금
SKD61 ~HRc55	SKD11 HRc55~	~HB225	HB225 ~325	HRc30~50	~FCD500					
○		○	◎	◎	○					

UB512 S6 2날 롱 넥 볼 엔드밀(자루경 6)

Endmill

품목코드	DC	RE	APMX	LU	OAL	DCONMS	품목코드	DC	RE	APMX	LU	OAL	DCONMS
	날경	반경 R	날장	유효장	전장	자루경		날경	반경 R	날장	유효장	전장	자루경
UB512 01022S6	1	0.5	1	22	60	6	UB512 01540S6	1.5	0.75	1.5	40	80	6
UB512 01026S6	1	0.5	1	26	60	6	UB512 02004S6	2	1	2	4	50	6
UB512 01030S6	1	0.5	1	30	70	6	UB512 02006S6	2	1	2	6	50	6
UB512 01503S6	1.5	0.75	1.5	3	50	6	UB512 02008S6	2	1	2	8	50	6
UB512 01504S6	1.5	0.75	1.5	4	50	6	UB512 02010S6	2	1	2	10	50	6
UB512 01506S6	1.5	0.75	1.5	6	50	6	UB512 02012S6	2	1	2	12	50	6
UB512 01508S6	1.5	0.75	1.5	8	50	6	UB512 02014S6	2	1	2	14	50	6
UB512 01510S6	1.5	0.75	1.5	10	50	6	UB512 02016S6	2	1	2	16	50	6
UB512 01512S6	1.5	0.75	1.5	12	50	6	UB512 02018S6	2	1	2	18	50	6
UB512 01514S6	1.5	0.75	1.5	14	50	6	UB512 02020S6	2	1	2	20	50	6
UB512 01516S6	1.5	0.75	1.5	16	50	6	UB512 02022S6	2	1	2	22	60	6
UB512 01518S6	1.5	0.75	1.5	18	50	6	UB512 02026S6	2	1	2	26	60	6
UB512 01520S6	1.5	0.75	1.5	20	55	6	UB512 02030S6	2	1	2	30	70	6
UB512 01522S6	1.5	0.75	1.5	22	60	6	UB512 02035S6	2	1	2	35	70	6
UB512 01526S6	1.5	0.75	1.5	26	60	6	UB512 02040S6	2	1	2	40	80	6
UB512 01530S6	1.5	0.75	1.5	30	70	6	UB512 02045S6	2	1	2	45	90	6
UB512 01535S6	1.5	0.75	1.5	35	70	6	UB512 02050S6	2	1	2	50	100	6

- Zamus Star
- E-Star
- U-Wing
- Zamus Thunder
- X-Star
- S-Wing
- A-Wing
- Standard
- Copper-Mate
- Gra-Mate

▶ 적용 피삭재

○ : 적합 ◎ : 매우 적합

H		P			K	N			M	S
열처리강		탄소강	합금강	프리하든강	주철	동	흑연	알루미늄	스테인리스	내열합금
SKD61 ~HRc55	SKD11 HRc55~	~HB225	HB225 ~325	HRc30~50	~FCD500					
○		○	◎	◎	○					

UB532

2날 롤리팝 스타일 볼 엔드밀

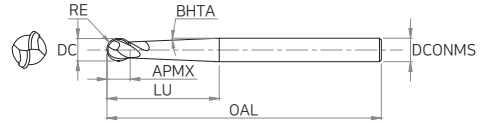

▶ 제품허용공차

날경(DC)		자루경
∅3 ~ ∅12	0 ~ -0.03	h5



품목코드	DC	RE	BHTA	APMX	LU	OAL	DCONMS
	날경	반경 R	테이퍼각	날장	유효장	전장	자루경
UB532 030	3	1.5	1.5	2.3	16	80	6
UB532 040	4	2	1.5	3.1	20	80	6
UB532 050	5	2.5	1.5	3.9	25	80	6
UB532 060	6	3	1.5	4.9	30	100	6
UB532 080	8	4	1.5	6.3	35	100	8
UB532 100	10	5	1.5	7.9	40	100	10
UB532 120	12	6	1.5	9.5	50	100	12

▶ 적용 피삭재

○ : 적합 ◎ : 매우 적합

H		P			K	N			M	S
열처리강		탄소강	합금강	프리하든강	주철	동	흑연	알루미늄	스테인리스	내열합금
SKD61 ~HRc55	SKD11 HRc55~	~HB225	HB225 ~325	HRc30~50	~FCD500					
○		○	◎	◎	○					

UB542 2날 테이퍼 넥 볼 엔드밀

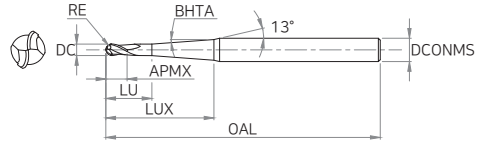

▶ 제품허용공차

날경(DC)		자루경
∅0.1 ~ ∅6	0 ~ -0.012	h5
∅8 ~ ∅12	0 ~ -0.015	

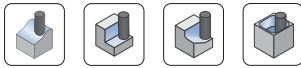

품목코드	DC	RE	BHTA	APMX	LU	LUX	OAL	DCONMS
	날경	Corner R	테이퍼각	날장	유효장	유효장	전장	자루경
UB542 00105005	0.1	0.05	0.5	0.1	-	0.5	40	4
UB542 0010501	0.1	0.05	0.5	0.1	-	1	40	4
UB542 00110005	0.1	0.05	1	0.1	-	0.5	40	4
UB542 0011001	0.1	0.05	1	0.1	-	1	40	4
UB542 00115005	0.1	0.05	1.5	0.1	-	0.5	40	4
UB542 0011501	0.1	0.05	1.5	0.1	-	1	40	4
UB542 00120005	0.1	0.05	2	0.1	-	0.5	40	4
UB542 0012001	0.1	0.05	2	0.1	-	1	40	4
UB542 00130005	0.1	0.05	3	0.1	-	0.5	40	4
UB542 0013001	0.1	0.05	3	0.1	-	1	40	4
UB542 0020501	0.2	0.1	0.5	0.2	0.4	1	40	4
UB542 0020502	0.2	0.1	0.5	0.2	0.4	2	40	4
UB542 0020503	0.2	0.1	0.5	0.2	0.4	3	40	4
UB542 0021001	0.2	0.1	1	0.2	0.4	1	40	4
UB542 0021002	0.2	0.1	1	0.2	0.4	2	40	4
UB542 0021003	0.2	0.1	1	0.2	0.4	3	40	4
UB542 0021501	0.2	0.1	1.5	0.2	0.4	1	40	4
UB542 0021502	0.2	0.1	1.5	0.2	0.4	2	40	4
UB542 0021503	0.2	0.1	1.5	0.2	0.4	3	40	4
UB542 0022001	0.2	0.1	2	0.2	0.4	1	40	4

▶ 적용 피삭재

○ : 적합 ◎ : 매우 적합

H		P			K	N			M	S
열처리강		탄소강	합금강	프리하든강	주철	동	흑연	알루미늄	스테인리스	내열합금
SKD61 ~HRC55	SKD11 HRC55~	~HB225	HB225 ~325	HRC30~50	~FCD500					
○		○	◎	◎	○					

UB542

2날 테이퍼 넥 볼 엔드밀

Endmill

품목코드	DC	RE	BHTA	APMX	LU	LUX	OAL	DCONMS
	날경	Corner R	테이퍼각	날장	유효장	유효장	전장	자루경
UB542 0022002	0.2	0.1	2	0.2	0.4	2	40	4
UB542 0022003	0.2	0.1	2	0.2	0.4	3	40	4
UB542 0023001	0.2	0.1	3	0.2	0.4	1	40	4
UB542 0023002	0.2	0.1	3	0.2	0.4	2	40	4
UB542 0023003	0.2	0.1	3	0.2	0.4	3	40	4
UB542 0025002	0.2	0.1	5	0.2	0.4	2	40	4
UB542 0025003	0.2	0.1	5	0.2	0.4	3	40	4
UB542 0030502	0.3	0.15	0.5	0.3	0.6	2	40	4
UB542 0030503	0.3	0.15	0.5	0.3	0.6	3	40	4
UB542 0030504	0.3	0.15	0.5	0.3	0.6	4	40	4
UB542 0030505	0.3	0.15	0.5	0.3	0.6	5	40	4
UB542 0031002	0.3	0.15	1	0.3	0.6	2	40	4
UB542 0031003	0.3	0.15	1	0.3	0.6	3	40	4
UB542 0031004	0.3	0.15	1	0.3	0.6	4	40	4
UB542 0031005	0.3	0.15	1	0.3	0.6	5	40	4
UB542 0031502	0.3	0.15	1.5	0.3	0.6	2	40	4
UB542 0031503	0.3	0.15	1.5	0.3	0.6	3	40	4
UB542 0031504	0.3	0.15	1.5	0.3	0.6	4	40	4
UB542 0031505	0.3	0.15	1.5	0.3	0.6	5	40	4
UB542 0032002	0.3	0.15	2	0.3	0.6	2	40	4
UB542 0032003	0.3	0.15	2	0.3	0.6	3	40	4
UB542 0032004	0.3	0.15	2	0.3	0.6	4	40	4
UB542 0032005	0.3	0.15	2	0.3	0.6	5	40	4
UB542 0033002	0.3	0.15	3	0.3	0.6	2	40	4
UB542 0033003	0.3	0.15	3	0.3	0.6	3	40	4
UB542 0033004	0.3	0.15	3	0.3	0.6	4	40	4
UB542 0033005	0.3	0.15	3	0.3	0.6	5	40	4
UB542 0035005	0.3	0.15	5	0.3	0.6	5	40	4
UB542 0040502	0.4	0.2	0.5	0.4	0.8	2	50	4
UB542 0040503	0.4	0.2	0.5	0.4	0.8	3	50	4
UB542 0040504	0.4	0.2	0.5	0.4	0.8	4	50	4
UB542 0040505	0.4	0.2	0.5	0.4	0.8	5	50	4
UB542 0040506	0.4	0.2	0.5	0.4	0.8	6	50	4
UB542 0041002	0.4	0.2	1	0.4	0.8	2	50	4

▶ 적용 피삭재

○ : 적합 ◎ : 매우 적합

H		P			K	N			M	S
열처리강		탄소강	합금강	프리하든강	주철	동	흑연	알루미늄	스테인리스	내열합금
SKD61 ~HRc55	SKD11 HRc55~	~HB225	HB225 ~325	HRc30~50	~FCD500					
○		○	◎	◎	○					

UB542 2날 테이퍼 넥 볼 엔드밀

Endmill

품목코드	DC	RE	BHTA	APMX	LU	LUX	OAL	DCONMS
	날경	Corner R	테이퍼각	날장	유효장	유효장	전장	자루경
UB542 0041003	0.4	0.2	1	0.4	0.8	3	50	4
UB542 0041004	0.4	0.2	1	0.4	0.8	4	50	4
UB542 0041005	0.4	0.2	1	0.4	0.8	5	50	4
UB542 0041006	0.4	0.2	1	0.4	0.8	6	50	4
UB542 0041502	0.4	0.2	1.5	0.4	0.8	2	50	4
UB542 0041503	0.4	0.2	1.5	0.4	0.8	3	50	4
UB542 0041504	0.4	0.2	1.5	0.4	0.8	4	50	4
UB542 0041505	0.4	0.2	1.5	0.4	0.8	5	50	4
UB542 0041506	0.4	0.2	1.5	0.4	0.8	6	50	4
UB542 0042002	0.4	0.2	2	0.4	0.8	2	50	4
UB542 0042003	0.4	0.2	2	0.4	0.8	3	50	4
UB542 0042004	0.4	0.2	2	0.4	0.8	4	50	4
UB542 0042005	0.4	0.2	2	0.4	0.8	5	50	4
UB542 0042006	0.4	0.2	2	0.4	0.8	6	50	4
UB542 0043002	0.4	0.2	3	0.4	0.8	2	50	4
UB542 0043003	0.4	0.2	3	0.4	0.8	3	50	4
UB542 0043004	0.4	0.2	3	0.4	0.8	4	50	4
UB542 0043005	0.4	0.2	3	0.4	0.8	5	50	4
UB542 0043006	0.4	0.2	3	0.4	0.8	6	50	4
UB542 0045004	0.4	0.2	5	0.4	0.8	4	50	4
UB542 0045006	0.4	0.2	5	0.4	0.8	6	50	4
UB542 0050504	0.5	0.25	0.5	0.5	1	4	50	4
UB542 0050506	0.5	0.25	0.5	0.5	1	6	50	4
UB542 0050508	0.5	0.25	0.5	0.5	1	8	50	4
UB542 0050510	0.5	0.25	0.5	0.5	1	10	50	4
UB542 0051004	0.5	0.25	1	0.5	1	4	50	4
UB542 0051006	0.5	0.25	1	0.5	1	6	50	4
UB542 0051008	0.5	0.25	1	0.5	1	8	50	4
UB542 0051010	0.5	0.25	1	0.5	1	10	50	4
UB542 0051504	0.5	0.25	1.5	0.5	1	4	50	4
UB542 0051506	0.5	0.25	1.5	0.5	1	6	50	4
UB542 0051508	0.5	0.25	1.5	0.5	1	8	50	4
UB542 0051510	0.5	0.25	1.5	0.5	1	10	50	4
UB542 0052004	0.5	0.25	2	0.5	1	4	50	4

Zamus Star

E-Star

U-Wing

Zamus Thunder

X-Star

S-Wing

A-Wing

Standard

Copper-Mate

Gra-Mate

▶ 적용 피삭재

○ : 적합 ◎ : 매우 적합

H		P			K	N			M	S
열처리강		탄소강	합금강	프리하트강	주철	동	흑연	알루미늄	스테인리스	내열합금
SKD61 ~HRc55	SKD11 HRc55~	~HB225	HB225 ~325	HRc30~50	~FCD500					
○		○	◎	◎	○					

UB542

2날 테이퍼 넥 볼 엔드밀

Endmill

품목코드	DC	RE	BHTA	APMX	LU	LUX	OAL	DCONMS
	날경	Corner R	테이퍼각	날장	유효장	유효장	전장	자루경
UB542 0052006	0.5	0.25	2	0.5	1	6	50	4
UB542 0052008	0.5	0.25	2	0.5	1	8	50	4
UB542 0052010	0.5	0.25	2	0.5	1	10	50	4
Zamus Star UB542 0053004	0.5	0.25	3	0.5	1	4	50	4
UB542 0053006	0.5	0.25	3	0.5	1	6	50	4
UB542 0053008	0.5	0.25	3	0.5	1	8	50	4
E-Star UB542 0053010	0.5	0.25	3	0.5	1	10	50	4
UB542 0060504	0.6	0.3	0.5	0.6	1.2	4	50	4
UB542 0060506	0.6	0.3	0.5	0.6	1.2	6	50	4
U-Wing UB542 0060508	0.6	0.3	0.5	0.6	1.2	8	50	4
UB542 0060510	0.6	0.3	0.5	0.6	1.2	10	50	4
UB542 0060512	0.6	0.3	0.5	0.6	1.2	12	50	4
Zamus Thunder UB542 0061004	0.6	0.3	1	0.6	1.2	4	50	4
UB542 0061006	0.6	0.3	1	0.6	1.2	6	50	4
UB542 0061008	0.6	0.3	1	0.6	1.2	8	50	4
UB542 0061010	0.6	0.3	1	0.6	1.2	10	50	4
UB542 0061012	0.6	0.3	1	0.6	1.2	12	50	4
X-Star UB542 0061504	0.6	0.3	1.5	0.6	1.2	4	50	4
UB542 0061506	0.6	0.3	1.5	0.6	1.2	6	50	4
UB542 0061508	0.6	0.3	1.5	0.6	1.2	8	50	4
S-Wing UB542 0061510	0.6	0.3	1.5	0.6	1.2	10	50	4
UB542 0061512	0.6	0.3	1.5	0.6	1.2	12	50	4
UB542 0062004	0.6	0.3	2	0.6	1.2	4	50	4
A-Wing UB542 0062006	0.6	0.3	2	0.6	1.2	6	50	4
UB542 0062008	0.6	0.3	2	0.6	1.2	8	50	4
UB542 0062010	0.6	0.3	2	0.6	1.2	10	50	4
UB542 0062012	0.6	0.3	2	0.6	1.2	12	50	4
Standard UB542 0063004	0.6	0.3	3	0.6	1.2	4	50	4
UB542 0063006	0.6	0.3	3	0.6	1.2	6	50	4
UB542 0063008	0.6	0.3	3	0.6	1.2	8	50	4
Copper-Mate UB542 0063010	0.6	0.3	3	0.6	1.2	10	50	4
UB542 0063012	0.6	0.3	3	0.6	1.2	12	50	4
UB542 0080504	0.8	0.4	0.5	0.8	1.6	4	50	4
Gra-Mate UB542 0080506	0.8	0.4	0.5	0.8	1.6	6	50	4

▶ 적용 피삭재

○ : 적합 ◎ : 매우 적합

H		P			K	N			M	S
열처리강		탄소강	합금강	프리하든강	주철	동	흑연	알루미늄	스테인리스	내열합금
SKD61 ~HRc55	SKD11 HRc55~	~HB225	HB225 ~325	HRc30~50	~FCD500					
○		○	◎	◎	○					

UB542 2날 테이퍼 넥 볼 엔드밀

Endmill

품목코드	DC	RE	BHTA	APMX	LU	LUX	OAL	DCONMS
	날경	Corner R	테이퍼각	날장	유효장	유효장	전장	자루경
UB542 0080508	0.8	0.4	0.5	0.8	1.6	8	50	4
UB542 0080510	0.8	0.4	0.5	0.8	1.6	10	50	4
UB542 0080512	0.8	0.4	0.5	0.8	1.6	12	50	4
UB542 0080516	0.8	0.4	0.5	0.8	1.6	16	50	4
UB542 0081004	0.8	0.4	1	0.8	1.6	4	50	4
UB542 0081006	0.8	0.4	1	0.8	1.6	6	50	4
UB542 0081008	0.8	0.4	1	0.8	1.6	8	50	4
UB542 0081010	0.8	0.4	1	0.8	1.6	10	50	4
UB542 0081012	0.8	0.4	1	0.8	1.6	12	50	4
UB542 0081016	0.8	0.4	1	0.8	1.6	16	50	4
UB542 0081504	0.8	0.4	1.5	0.8	1.6	4	50	4
UB542 0081506	0.8	0.4	1.5	0.8	1.6	6	50	4
UB542 0081508	0.8	0.4	1.5	0.8	1.6	8	50	4
UB542 0081510	0.8	0.4	1.5	0.8	1.6	10	50	4
UB542 0081512	0.8	0.4	1.5	0.8	1.6	12	50	4
UB542 0081516	0.8	0.4	1.5	0.8	1.6	16	50	4
UB542 0082004	0.8	0.4	2	0.8	1.6	4	50	4
UB542 0082006	0.8	0.4	2	0.8	1.6	6	50	4
UB542 0082008	0.8	0.4	2	0.8	1.6	8	50	4
UB542 0082010	0.8	0.4	2	0.8	1.6	10	50	4
UB542 0082012	0.8	0.4	2	0.8	1.6	12	50	4
UB542 0082016	0.8	0.4	2	0.8	1.6	16	50	4
UB542 0083004	0.8	0.4	3	0.8	1.6	4	50	4
UB542 0083006	0.8	0.4	3	0.8	1.6	6	50	4
UB542 0083008	0.8	0.4	3	0.8	1.6	8	50	4
UB542 0083010	0.8	0.4	3	0.8	1.6	10	50	4
UB542 0083012	0.8	0.4	3	0.8	1.6	12	50	4
UB542 0083016	0.8	0.4	3	0.8	1.6	16	50	4
UB542 0100506	1	0.5	0.5	1	2.5	6	50	4
UB542 0100508	1	0.5	0.5	1	2.5	8	50	4
UB542 0100510	1	0.5	0.5	1	2.5	10	50	4
UB542 0100512	1	0.5	0.5	1	2.5	12	50	4
UB542 0100516	1	0.5	0.5	1	2.5	16	50	4
UB542 0100520	1	0.5	0.5	1	2.5	20	50	4

Zamus Star

E-Star

U-Wing

Zamus Thunder

X-Star

S-Wing

A-Wing

Standard

Copper-Mate

Gra-Mate

▶ 적용 피삭재

○ : 적합 ◎ : 매우 적합

H		P			K	N			M	S
열처리강		탄소강	합금강	프리하트강	주철	동	흑연	알루미늄	스테인리스	내열합금
SKD61 ~HRC55	SKD11 HRC55~	~HB225	HB225 ~325	HRC30~50	~FCD500					
○		○	◎	◎	○					

UB542

2날 테이퍼 넥 볼 엔드밀

Endmill

품목코드	DC	RE	BHTA	APMX	LU	LUX	OAL	DCONMS
	날경	Corner R	테이퍼각	날장	유효장	유효장	전장	자루경
UB542 0100525	1	0.5	0.5	1	2.5	25	60	4
UB542 0100530	1	0.5	0.5	1	2.5	30	70	4
UB542 0100540	1	0.5	0.5	1	2.5	40	80	4
UB542 0100550	1	0.5	0.5	1	2.5	50	90	4
UB542 0101006	1	0.5	1	1	2.5	6	50	4
UB542 0101008	1	0.5	1	1	2.5	8	50	4
UB542 0101010	1	0.5	1	1	2.5	10	50	4
UB542 0101012	1	0.5	1	1	2.5	12	50	4
UB542 0101016	1	0.5	1	1	2.5	16	50	4
UB542 0101020	1	0.5	1	1	2.5	20	50	4
UB542 0101025	1	0.5	1	1	2.5	25	60	4
UB542 0101030	1	0.5	1	1	2.5	30	70	4
UB542 0101040	1	0.5	1	1	2.5	40	80	4
UB542 0101050	1	0.5	1	1	2.5	50	90	4
UB542 0101506	1	0.5	1.5	1	2.5	6	50	4
UB542 0101508	1	0.5	1.5	1	2.5	8	50	4
UB542 0101510	1	0.5	1.5	1	2.5	10	50	4
UB542 0101512	1	0.5	1.5	1	2.5	12	50	4
UB542 0101516	1	0.5	1.5	1	2.5	16	50	4
UB542 0101520	1	0.5	1.5	1	2.5	20	50	4
UB542 0101525	1	0.5	1.5	1	2.5	25	60	4
UB542 0101530	1	0.5	1.5	1	2.5	30	70	4
UB542 0101540	1	0.5	1.5	1	2.5	40	80	4
UB542 0101550	1	0.5	1.5	1	2.5	50	90	4
UB542 0102006	1	0.5	2	1	2.5	6	50	4
UB542 0102008	1	0.5	2	1	2.5	8	50	4
UB542 0102010	1	0.5	2	1	2.5	10	50	4
UB542 0102012	1	0.5	2	1	2.5	12	50	4
UB542 0102016	1	0.5	2	1	2.5	16	50	4
UB542 0102020	1	0.5	2	1	2.5	20	50	4
UB542 0102025	1	0.5	2	1	2.5	25	60	4
UB542 0102030	1	0.5	2	1	2.5	30	70	4
UB542 0102040	1	0.5	2	1	2.5	40	80	4
UB542 0102050	1	0.5	2	1	2.5	50	90	6

▶ 적용 피삭재

○ : 적합 ◎ : 매우 적합

H		P			K	N			M	S
열처리강		탄소강	합금강	프리하든강	주철	동	흑연	알루미늄	스테인리스	내열합금
SKD61 ~HRc55	SKD11 HRc55~	~HB225	HB225 ~325	HRc30~50	~FCD500					
○		○	◎	◎	○					

UB542 2날 테이퍼 넥 볼 엔드밀

Endmill

품목코드	DC	RE	BHTA	APMX	LU	LUX	OAL	DCONMS
	날경	Corner R	테이퍼각	날장	유효장	유효장	전장	자루경
UB542 0103006	1	0.5	3	1	2.5	6	50	4
UB542 0103008	1	0.5	3	1	2.5	8	50	4
UB542 0103010	1	0.5	3	1	2.5	10	50	4
UB542 0103012	1	0.5	3	1	2.5	12	50	4
UB542 0103016	1	0.5	3	1	2.5	16	50	4
UB542 0103020	1	0.5	3	1	2.5	20	50	4
UB542 0103025	1	0.5	3	1	2.5	25	60	4
UB542 0103030	1	0.5	3	1	2.5	30	70	6
UB542 0103040	1	0.5	3	1	2.5	40	80	6
UB542 0103050	1	0.5	3	1	2.5	50	90	6
UB542 0105030	1	0.5	5	1	2.5	30	70	6
UB542 0120508	1.2	0.6	0.5	1.2	3	8	50	4
UB542 0120512	1.2	0.6	0.5	1.2	3	12	50	4
UB542 0120516	1.2	0.6	0.5	1.2	3	16	50	4
UB542 0120520	1.2	0.6	0.5	1.2	3	20	50	4
UB542 0120525	1.2	0.6	0.5	1.2	3	25	60	4
UB542 0120530	1.2	0.6	0.5	1.2	3	30	70	4
UB542 0121008	1.2	0.6	1	1.2	3	8	50	4
UB542 0121012	1.2	0.6	1	1.2	3	12	50	4
UB542 0121016	1.2	0.6	1	1.2	3	16	50	4
UB542 0121020	1.2	0.6	1	1.2	3	20	50	4
UB542 0121025	1.2	0.6	1	1.2	3	25	60	4
UB542 0121030	1.2	0.6	1	1.2	3	30	70	4
UB542 0121508	1.2	0.6	1.5	1.2	3	8	50	4
UB542 0121512	1.2	0.6	1.5	1.2	3	12	50	4
UB542 0121516	1.2	0.6	1.5	1.2	3	16	50	4
UB542 0121520	1.2	0.6	1.5	1.2	3	20	50	4
UB542 0121525	1.2	0.6	1.5	1.2	3	25	60	4
UB542 0121530	1.2	0.6	1.5	1.2	3	30	70	4
UB542 0122008	1.2	0.6	2	1.2	3	8	50	4
UB542 0122012	1.2	0.6	2	1.2	3	12	50	4
UB542 0122016	1.2	0.6	2	1.2	3	16	50	4
UB542 0122020	1.2	0.6	2	1.2	3	20	50	4
UB542 0122025	1.2	0.6	2	1.2	3	25	60	4

Zamus Star
E-Star
U-Wing
Zamus Thunder
X-Star
S-Wing
A-Wing
Standard
Copper-Mate
Gra-Mate

▶ 적용 피삭재

○ : 적합 ◎ : 매우 적합

H		P			K	N			M	S
열처리강		탄소강	합금강	프리하든강	주철	동	흑연	알루미늄	스테인리스	내열합금
SKD61 ~HRc55	SKD11 HRc55~	~HB225	HB225 ~325	HRc30~50	~FCD500					
○		○	◎	◎	○					

UB542

2날 테이퍼 넥 볼 엔드밀

Endmill

품목코드	DC	RE	BHTA	APMX	LU	LUX	OAL	DCONMS
	날경	Corner R	테이퍼각	날장	유효장	유효장	전장	자루경
UB542 0122030	1.2	0.6	2	1.2	3	30	70	4
UB542 0123008	1.2	0.6	3	1.2	3	8	50	4
UB542 0123012	1.2	0.6	3	1.2	3	12	50	4
UB542 0123016	1.2	0.6	3	1.2	3	16	50	4
UB542 0123020	1.2	0.6	3	1.2	3	20	50	4
UB542 0123025	1.2	0.6	3	1.2	3	25	60	4
UB542 0123030	1.2	0.6	5	1.2	3	30	70	6
UB542 0150508	1.5	0.75	0.5	1.5	4	8	50	4
UB542 0150510	1.5	0.75	0.5	1.5	4	10	50	4
UB542 0150512	1.5	0.75	0.5	1.5	4	12	50	4
UB542 0150516	1.5	0.75	0.5	1.5	4	16	50	4
UB542 0150520	1.5	0.75	0.5	1.5	4	20	50	4
UB542 0150525	1.5	0.75	0.5	1.5	4	25	60	4
UB542 0150530	1.5	0.75	0.5	1.5	4	30	70	4
UB542 0150540	1.5	0.75	0.5	1.5	4	40	80	4
UB542 0150550	1.5	0.75	0.5	1.5	4	50	90	4
UB542 0151008	1.5	0.75	1	1.5	4	8	50	4
UB542 0151010	1.5	0.75	1	1.5	4	10	50	4
UB542 0151012	1.5	0.75	1	1.5	4	12	50	4
UB542 0151016	1.5	0.75	1	1.5	4	16	50	4
UB542 0151020	1.5	0.75	1	1.5	4	20	50	4
UB542 0151025	1.5	0.75	1	1.5	4	25	60	4
UB542 0151030	1.5	0.75	1	1.5	4	30	70	4
UB542 0151040	1.5	0.75	1	1.5	4	40	80	4
UB542 0151050	1.5	0.75	1	1.5	4	50	90	4
UB542 0151508	1.5	0.75	1.5	1.5	4	8	50	4
UB542 0151510	1.5	0.75	1.5	1.5	4	10	50	4
UB542 0151512	1.5	0.75	1.5	1.5	4	12	50	4
UB542 0151516	1.5	0.75	1.5	1.5	4	16	50	4
UB542 0151520	1.5	0.75	1.5	1.5	4	20	50	4
UB542 0151525	1.5	0.75	1.5	1.5	4	25	60	4
UB542 0151530	1.5	0.75	1.5	1.5	4	30	70	4
UB542 0151540	1.5	0.75	1.5	1.5	4	40	80	4
UB542 0151550	1.5	0.75	1.5	1.5	4	50	90	4

▶ 적용 피삭재

○ : 적합 ◎ : 매우 적합

H		P			K	N			M	S
열처리강		탄소강	합금강	프리하든강	주철	동	흑연	알루미늄	스테인리스	내열합금
SKD61 ~HRc55	SKD11 HRc55~	~HB225	HB225 ~325	HRc30~50	~FCD500					
○		○	◎	◎	○					

UB542 2날 테이퍼 넥 볼 엔드밀

Endmill

품목코드	DC	RE	BHTA	APMX	LU	LUX	OAL	DCONMS
	날경	Corner R	테이퍼각	날장	유효장	유효장	전장	자루경
UB542 0121016	1.2	0.6	1	1.2	3	16	50	4
UB542 0121020	1.2	0.6	1	1.2	3	20	50	4
UB542 0121025	1.2	0.6	1	1.2	3	25	60	4
UB542 0121030	1.2	0.6	1	1.2	3	30	70	4
UB542 0121508	1.2	0.6	1.5	1.2	3	8	50	4
UB542 0121512	1.2	0.6	1.5	1.2	3	12	50	4
UB542 0121516	1.2	0.6	1.5	1.2	3	16	50	4
UB542 0121520	1.2	0.6	1.5	1.2	3	20	50	4
UB542 0121525	1.2	0.6	1.5	1.2	3	25	60	4
UB542 0121530	1.2	0.6	1.5	1.2	3	30	70	4
UB542 0122008	1.2	0.6	2	1.2	3	8	50	4
UB542 0122012	1.2	0.6	2	1.2	3	12	50	4
UB542 0122016	1.2	0.6	2	1.2	3	16	50	4
UB542 0122020	1.2	0.6	2	1.2	3	20	50	4
UB542 0122025	1.2	0.6	2	1.2	3	25	60	4
UB542 0122030	1.2	0.6	2	1.2	3	30	70	4
UB542 0123008	1.2	0.6	3	1.2	3	8	50	4
UB542 0123012	1.2	0.6	3	1.2	3	12	50	4
UB542 0123016	1.2	0.6	3	1.2	3	16	50	4
UB542 0123020	1.2	0.6	3	1.2	3	20	50	4
UB542 0123025	1.2	0.6	3	1.2	3	25	60	4
UB542 0123030	1.2	0.6	5	1.2	3	30	70	6
UB542 0150508	1.5	0.75	0.5	1.5	4	8	50	4
UB542 0150510	1.5	0.75	0.5	1.5	4	10	50	4
UB542 0150512	1.5	0.75	0.5	1.5	4	12	50	4
UB542 0150516	1.5	0.75	0.5	1.5	4	16	50	4
UB542 0150520	1.5	0.75	0.5	1.5	4	20	50	4
UB542 0150525	1.5	0.75	0.5	1.5	4	25	60	4
UB542 0150530	1.5	0.75	0.5	1.5	4	30	70	4
UB542 0150540	1.5	0.75	0.5	1.5	4	40	80	4
UB542 0150550	1.5	0.75	0.5	1.5	4	50	90	4
UB542 0151008	1.5	0.75	1	1.5	4	8	50	4
UB542 0151010	1.5	0.75	1	1.5	4	10	50	4
UB542 0151012	1.5	0.75	1	1.5	4	12	50	4

Zamus Star
E-Star
U-Wing
Zamus Thunder
X-Star
S-Wing
A-Wing
Standard
Copper-Mate
Gra-Mate

▶ 적용 피삭재

○ : 적합 ◎ : 매우 적합

H		P			K	N			M	S
열처리강		탄소강	합금강	프리하든강	주철	동	흑연	알루미늄	스테인리스	내열합금
SKD61 ~HRc55	SKD11 HRc55~	~HB225	HB225 ~325	HRc30~50	~FCD500					
○		○	◎	◎	○					

UB542

2날 테이퍼 넥 볼 엔드밀

Endmill

품목코드	DC	RE	BHTA	APMX	LU	LUX	OAL	DCONMS
	날경	Corner R	테이퍼각	날장	유효장	유효장	전장	자루경
UB542 0151016	1.5	0.75	1	1.5	4	16	50	4
UB542 0151020	1.5	0.75	1	1.5	4	20	50	4
UB542 0151025	1.5	0.75	1	1.5	4	25	60	4
UB542 0151030	1.5	0.75	1	1.5	4	30	70	4
UB542 0151040	1.5	0.75	1	1.5	4	40	80	4
UB542 0151050	1.5	0.75	1	1.5	4	50	90	4
UB542 0151508	1.5	0.75	1.5	1.5	4	8	50	4
UB542 0151510	1.5	0.75	1.5	1.5	4	10	50	4
UB542 0151512	1.5	0.75	1.5	1.5	4	12	50	4
UB542 0151516	1.5	0.75	1.5	1.5	4	16	50	4
UB542 0151520	1.5	0.75	1.5	1.5	4	20	50	4
UB542 0151525	1.5	0.75	1.5	1.5	4	25	60	4
UB542 0151530	1.5	0.75	1.5	1.5	4	30	70	4
UB542 0151540	1.5	0.75	1.5	1.5	4	40	80	4
UB542 0151550	1.5	0.75	1.5	1.5	4	50	90	4
UB542 0152008	1.5	0.75	2	1.5	4	8	50	4
UB542 0152010	1.5	0.75	2	1.5	4	10	50	4
UB542 0152012	1.5	0.75	2	1.5	4	12	50	4
UB542 0152016	1.5	0.75	2	1.5	4	16	50	4
UB542 0152020	1.5	0.75	2	1.5	4	20	50	4
UB542 0152025	1.5	0.75	2	1.5	4	25	60	4
UB542 0152030	1.5	0.75	2	1.5	4	30	70	4
UB542 0152040	1.5	0.75	2	1.5	4	40	80	6
UB542 0152050	1.5	0.75	2	1.5	4	50	90	6
UB542 0153020	1.5	0.75	3	1.5	4	20	50	6
UB542 0153030	1.5	0.75	3	1.5	4	30	70	6
UB542 0153040	1.5	0.75	3	1.5	4	40	80	6
UB542 0153050	1.5	0.75	3	1.5	4	50	90	8
UB542 0155030	1.5	0.75	5	1.5	4	30	70	8
UB542 0200510	2	1	0.5	2	5	10	50	4
UB542 0200512	2	1	0.5	2	5	12	50	4
UB542 0200516	2	1	0.5	2	5	16	50	4
UB542 0200520	2	1	0.5	2	5	20	50	4
UB542 0200525	2	1	0.5	2	5	25	60	4

▶ 적용 피삭재

○ : 적합 ◎ : 매우 적합

H		P			K	N			M	S
열처리강		탄소강	합금강	프리하든강	주철	동	흑연	알루미늄	스테인리스	내열합금
SKD61 ~HRc55	SKD11 HRc55~	~HB225	HB225 ~325	HRc30~50	~FCD500					
○		○	◎	◎	○					

UB542 2날 테이퍼 넥 볼 엔드밀

Endmill

품목코드	DC	RE	BHTA	APMX	LU	LUX	OAL	DCONMS
	날경	Corner R	테이퍼각	날장	유효장	유효창	전장	자루경
UB542 0200530	2	1	0.5	2	5	30	70	4
UB542 0200540	2	1	0.5	2	5	40	80	4
UB542 0200550	2	1	0.5	2	5	50	100	6
UB542 0200560	2	1	0.5	2	5	60	100	6
UB542 0200580	2	1	0.5	2	5	80	140	6
UB542 0201010	2	1	1	2	5	10	50	4
UB542 0201012	2	1	1	2	5	12	50	4
UB542 0201016	2	1	1	2	5	16	50	4
UB542 0201020	2	1	1	2	5	20	50	4
UB542 0201025	2	1	1	2	5	25	60	4
UB542 0201030	2	1	1	2	5	30	70	4
UB542 0201040	2	1	1	2	5	40	80	6
UB542 0201050	2	1	1	2	5	50	100	6
UB542 0201060	2	1	1	2	5	60	100	6
UB542 0201080	2	1	1	2	5	80	140	6
UB542 0201510	2	1	1.5	2	5	10	50	4
UB542 0201512	2	1	1.5	2	5	12	50	4
UB542 0201516	2	1	1.5	2	5	16	50	4
UB542 0201520	2	1	1.5	2	5	20	50	4
UB542 0201525	2	1	1.5	2	5	25	60	4
UB542 0201530	2	1	1.5	2	5	30	70	6
UB542 0201540	2	1	1.5	2	5	40	80	6
UB542 0201550	2	1	1.5	2	5	50	100	6
UB542 0201560	2	1	1.5	2	5	60	100	6
UB542 0201580	2	1	1.5	2	5	80	140	6
UB542 0202010	2	1	2	2	5	10	50	4
UB542 0202012	2	1	2	2	5	12	50	4
UB542 0202016	2	1	2	2	5	16	50	4
UB542 0202020	2	1	2	2	5	20	55	4
UB542 0202025	2	1	2	2	5	25	60	4
UB542 0202030	2	1	2	2	5	30	70	4
UB542 0202040	2	1	2	2	5	40	80	6
UB542 0202050	2	1	2	2	5	50	90	6
UB542 0202060	2	1	2	2	5	60	100	6

Zamus Star

E-Star

U-Wing

Zamus Thunder

X-Star

S-Wing

A-Wing

Standard

Copper-Mate

Gra-Mate

▶ 적용 피삭재

○ : 적합 ◎ : 매우 적합

H		P			K	N			M	S
열처리강		탄소강	합금강	프리하트강	주철	동	흑연	알루미늄	스테인리스	내열합금
SKD61 ~HRc55	SKD11 HRc55~	~HB225	HB225 ~325	HRc30~50	~FCD500					
○		○	◎	◎	○					

UB542

2날 테이퍼 넥 볼 엔드밀

Endmill

품목코드	DC	RE	BHTA	APMX	LU	LUX	OAL	DCONMS
	날경	Corner R	테이퍼각	날장	유효장	유효장	전장	자루경
UB542 0202080	2	1	2	2	5	80	140	8
UB542 0203030	2	1	3	2	5	30	70	6
UB542 0203040	2	1	3	2	5	40	80	6
UB542 0203050	2	1	3	2	5	50	90	8
UB542 0203060	2	1	3	2	5	60	100	8
UB542 0203080	2	1	3	2	5	80	140	10
UB542 0205030	2	1	5	2	5	30	70	8
UB542 0205040	2	1	5	2	5	40	90	10
UB542 0300516	3	1.5	0.5	4.5	6	16	60	6
UB542 0300520	3	1.5	0.5	4.5	6	20	65	6
UB542 0300530	3	1.5	0.5	4.5	6	30	70	6
UB542 0300540	3	1.5	0.5	4.5	6	40	80	6
UB542 0300550	3	1.5	0.5	4.5	6	50	90	6
UB542 0300560	3	1.5	0.5	4.5	6	60	100	6
UB542 0301016	3	1.5	1	4.5	6	16	60	6
UB542 0301020	3	1.5	1	4.5	6	20	65	6
UB542 0301030	3	1.5	1	4.5	6	30	70	6
UB542 0301040	3	1.5	1	4.5	6	40	80	6
UB542 0301050	3	1.5	1	4.5	6	50	90	6
UB542 0301060	3	1.5	1	4.5	6	60	100	6
UB542 0301070	3	1.5	1	4.5	6	70	120	6
UB542 0301516	3	1.5	1.5	4.5	6	16	60	6
UB542 0301520	3	1.5	1.5	4.5	6	20	65	6
UB542 0301530	3	1.5	1.5	4.5	6	30	70	6
UB542 0301540	3	1.5	1.5	4.5	6	40	80	6
UB542 0301550	3	1.5	1.5	4.5	6	50	90	6
UB542 0301560	3	1.5	1.5	4.5	6	60	100	6
UB542 0302016	3	1.5	2	4.5	6	16	60	6
UB542 0302020	3	1.5	2	4.5	6	20	65	6
UB542 0302030	3	1.5	2	4.5	6	30	70	6
UB542 0302040	3	1.5	2	4.5	6	40	80	6
UB542 0302050	3	1.5	2	4.5	6	50	90	8
UB542 0303030	3	1.5	3	4.5	6	30	70	6
UB542 0303040	3	1.5	3	4.5	6	40	90	8

▶ 적용 피삭재

○ : 적합 ◎ : 매우 적합

H		P			K	N			M	S
열처리강		탄소강	합금강	프리하든강	주철	동	흑연	알루미늄	스테인리스	내열합금
SKD61 ~HRc55	SKD11 HRc55~	~HB225	HB225 ~325	HRc30~50	~FCD500					
○		○	◎	◎	○					

UB542 2날 테이퍼 넥 볼 엔드밀

Endmill

품목코드	DC	RE	BHTA	APMX	LU	LUX	OAL	DCONMS
	날경	Corner R	테이퍼각	날장	유효장	유효창	전장	자루경
UB542 0305030	3	1.5	5	4.5	6	30	70	8
UB542 0305040	3	1.5	5	4.5	6	40	90	10
UB542 0400540	4	2	0.5	6	8	40	90	6
UB542 0400550	4	2	0.5	6	8	50	100	6
UB542 0400560	4	2	0.5	6	8	60	110	6
UB542 0400570	4	2	0.5	6	8	70	120	6
UB542 0401040	4	2	1	6	8	40	90	6
UB542 0401050	4	2	1	6	8	50	100	6
UB542 0401060	4	2	1	6	8	60	110	8
UB542 0401070	4	2	1	6	8	70	120	8
UB542 0401540	4	2	1.5	6	8	40	90	6
UB542 0401550	4	2	1.5	6	8	50	100	8
UB542 0401560	4	2	1.5	6	8	60	110	8
UB542 0401570	4	2	1.5	6	8	70	120	8
UB542 0403050	4	2	3	6	8	50	100	10
UB542 0405050	4	2	5	6	8	50	100	12
UB542 0501060	5	2.5	1	10	13	60	120	8
UB542 0501560	5	2.5	1.5	10	13	60	120	8
UB542 0503040	5	2.5	3	10	13	40	120	8
UB542 0601060	6	3	1	12	15	60	120	8
UB542 0601090	6	3	1	12	15	90	150	10
UB542 0601560	6	3	1.5	12	15	60	120	10
UB542 0601590	6	3	1.5	12	15	90	150	10
UB542 0602060	6	3	2	12	15	60	120	10
UB542 0602090	6	3	2	12	15	90	150	12
UB542 0603060	6	3	3	12	15	60	120	12
UB542 0603090	6	3	3	12	15	90	150	14
UB542 08010100	8	4	1	14	18	100	150	12
UB542 0801070	8	4	1	14	18	70	130	10
UB542 08015100	8	4	1.5	14	18	100	150	14
UB542 0801570	8	4	1.5	14	18	70	130	12
UB542 08020100	8	4	2	14	18	100	150	14
UB542 0802070	8	4	2	14	18	70	130	12
UB542 08030100	8	4	3	14	18	100	150	18

Zamus Star

E-Star

U-Wing

Zamus Thunder

X-Star

S-Wing

A-Wing

Standard

Copper-Mate

Gra-Mate

▶ 적용 피삭재

○ : 적합 ◎ : 매우 적합

H		P			K	N			M	S
열처리강		탄소강	합금강	프리하든강	주철	동	흑연	알루미늄	스테인리스	내열합금
SKD61 ~HRc55	SKD11 HRc55~	~HB225	HB225 ~325	HRc30~50	~FCD500					
○		○	◎	◎	○					

UB542

2날 테이퍼 넥 볼 엔드밀

Endmill

품목코드	DC	RE	BHTA	APMX	LU	LUX	OAL	DCONMS
	날경	Corner R	테이퍼각	날장	유효장	유효장	전장	자루경
UB542 0803070	8	4	3	14	18	70	130	14
UB542 10010100	10	5	1	18	22	100	200	14
UB542 1001070	10	5	1	18	22	70	130	12
UB542 1001080	10	5	1	18	22	80	150	14
UB542 10015100	10	5	1.5	18	22	100	200	16
UB542 1001570	10	5	1.5	18	22	70	130	14
UB542 1001580	10	5	1.5	18	22	80	150	14
UB542 10020100	10	5	2	18	22	100	200	16
UB542 1002070	10	5	2	18	22	70	130	14
UB542 1002080	10	5	2	18	22	80	150	16
UB542 10030100	10	5	3	18	22	100	200	20
UB542 1003070	10	5	3	18	22	70	130	16
UB542 1003080	10	5	3	18	22	80	150	18
UB542 12010100	12	6	1	22	25	100	200	16
UB542 1201060	12	6	1	22	25	60	130	14
UB542 1201080	12	6	1	22	25	80	150	14
UB542 1201090	12	6	1	22	25	90	180	16
UB542 12015100	12	6	1.5	22	25	100	200	16
UB542 1201560	12	6	1.5	22	25	60	130	14
UB542 1201580	12	6	1.5	22	25	80	150	16
UB542 1201590	12	6	1.5	22	25	90	180	16
UB542 12020100	12	6	2	22	25	100	200	18
UB542 1202060	12	6	2	22	25	60	130	16
UB542 1202080	12	6	2	22	25	80	150	16
UB542 1202090	12	6	2	22	25	90	180	18
UB542 12030100	12	6	3	22	25	100	200	20
UB542 1203060	12	6	3	22	25	60	130	16
UB542 1203080	12	6	3	22	25	80	150	18
UB542 1203090	12	6	3	22	25	90	180	20

Zamus Star

E-Star

U-Wing

Zamus Thunder

X-Star

S-Wing

A-Wing

Standard

Copper-Mate

Gra-Mate

▶ 적용 피삭재

○ : 적합 ◎ : 매우 적합

H		P			K	N			M	S
열처리강		탄소강	합금강	프리하든강	주철	동	흑연	알루미늄	스테인리스	내열합금
SKD61 ~HRc55	SKD11 HRc55~	~HB225	HB225 ~325	HRc30~50	~FCD500					
○		○	◎	◎	○					

UTB502

2날 테이퍼 볼 엔드밀

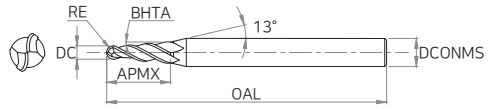

▶ 제품허용공차

날경(DC)		자루경
∅0.3 ~ ∅2	0 ~ -0.03	h5

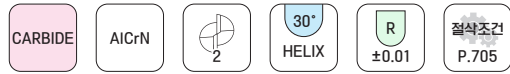

품목코드	DC	RE	BHTA	APMX	OAL	DCONMS
	날경	Corner R	테이퍼각	날장	전장	자루경
UTB502 00305	0.3	0.15	5	1.2	40	4
UTB502 00303	0.3	0.15	3	1.2	40	4
UTB502 00302	0.3	0.15	2	1.2	40	4
UTB502 003015	0.3	0.15	1.5	1.2	40	4
UTB502 00301	0.3	0.15	1	1.2	40	4
UTB502 003005	0.3	0.15	0.5	1.2	40	4
UTB502 00310	0.3	0.15	10	1.5	40	4
UTB502 00307	0.3	0.15	7	1.5	40	4
UTB502 00405	0.4	0.2	5	1.6	40	4
UTB502 00403	0.4	0.2	3	1.6	40	4
UTB502 00402	0.4	0.2	2	1.6	40	4
UTB502 004015	0.4	0.2	1.5	1.6	40	4
UTB502 00401	0.4	0.2	1	1.6	40	4
UTB502 004005	0.4	0.2	0.5	1.6	40	4
UTB502 00410	0.4	0.2	10	2	40	4
UTB502 00407	0.4	0.2	7	2	40	4
UTB502 00505	0.5	0.25	5	2	45	4
UTB502 00503	0.5	0.25	3	2	45	4
UTB502 00502	0.5	0.25	2	2	45	4
UTB502 005015	0.5	0.25	1.5	2	45	4

▶ 적용 피삭재

○ : 적합 ◎ : 매우 적합

H		P			K	N			M	S
열처리강		탄소강	합금강	프리하든강	주철	동	흑연	알루미늄	스테인리스	내열합금
SKD61 ~HRC55	SKD11 HRC55~	~HB225	HB225 ~325	HRC30~50	~FCD500					
○		○	◎	◎	○					

UTB502 2날 테이퍼 볼 엔드밀

Endmill

품목코드	DC	RE	BHTA	APMX	OAL	DCONMS
	날경	Corner R	테이퍼각	날장	전장	자루경
UTB502 00501	0.5	0.25	1	2	45	4
UTB502 005005	0.5	0.25	0.5	2	45	4
UTB502 00510	0.5	0.25	10	2.5	45	4
UTB502 00507	0.5	0.25	7	2.5	45	4
UTB502 00605	0.6	0.3	5	2	45	4
UTB502 00603	0.6	0.3	3	2	45	4
UTB502 00602	0.6	0.3	2	2	45	4
UTB502 006015	0.6	0.3	1.5	2	45	4
UTB502 00601	0.6	0.3	1	2	45	4
UTB502 006005	0.6	0.3	0.5	2	45	4
UTB502 00610	0.6	0.3	10	2.5	45	4
UTB502 00607	0.6	0.3	7	2.5	45	4
UTB502 00705	0.7	0.35	5	2.5	45	4
UTB502 00703	0.7	0.35	3	2.5	45	4
UTB502 00702	0.7	0.35	2	2.5	45	4
UTB502 007015	0.7	0.35	1.5	2.5	45	4
UTB502 00701	0.7	0.35	1	2.5	45	4
UTB502 007005	0.7	0.35	0.5	2.5	45	4
UTB502 00710	0.7	0.35	10	3	45	4
UTB502 00707	0.7	0.35	7	3	45	4
UTB502 00810	0.8	0.4	10	3.2	45	4
UTB502 00807	0.8	0.4	7	3.2	45	4
UTB502 00805	0.8	0.4	5	3.2	45	4
UTB502 00803	0.8	0.4	3	3.2	45	4
UTB502 00802	0.8	0.4	2	3.2	45	4
UTB502 008015	0.8	0.4	1.5	3.2	45	4
UTB502 00801	0.8	0.4	1	3.2	45	4
UTB502 008005	0.8	0.4	0.5	3.2	45	4
UTB502 01010	1	0.5	10	4	50	4
UTB502 01007	1	0.5	7	4	50	4
UTB502 01005	1	0.5	5	4	50	4
UTB502 01003	1	0.5	3	4	50	4
UTB502 01002	1	0.5	2	4	50	4
UTB502 010015	1	0.5	1.5	4	50	4

▶ 적용 피삭재

○ : 적합 ◎ : 매우 적합

H		P			K	N			M	S
열처리강		탄소강	합금강	프리하든강	주철	동	흑연	알루미늄	스테인리스	내열합금
SKD61 ~HRc55	SKD11 HRc55~	~HB225	HB225 ~325	HRc30~50	~FCD500					
○		○	◎	◎	○					

UTB502

2날 테이퍼 볼 엔드밀

Endmill

품목코드	DC	RE	BHTA	APMX	OAL	DCONMS
	날경	Corner R	테이퍼각	날장	전장	자루경
UTB502 01001	1	0.5	1	4	50	4
UTB502 010005	1	0.5	0.5	4	50	4
UTB502 015015	1.5	0.75	1.5	6	50	4
UTB502 01501	1.5	0.75	1	6	50	4
UTB502 015005	1.5	0.75	0.5	6	50	4
UTB502 01502	1.5	0.75	2	7	50	4
UTB502 01503	1.5	0.75	3	8	50	4
UTB502 01510	1.5	0.75	10	10	50	6
UTB502 01507	1.5	0.75	7	10	50	4
UTB502 01505	1.5	0.75	5	10	50	4
UTB502 020015	2	1	1.5	6	50	4
UTB502 02001	2	1	1	6	50	4
UTB502 020005	2	1	0.5	6	50	4
UTB502 02007	2	1	7	10	50	6
UTB502 02005	2	1	5	10	50	4
UTB502 02003	2	1	3	10	50	4
UTB502 02002	2	1	2	10	50	4
UTB502 02010	2	1	10	11	50	6

- Zamus Star
- E-Star
- U-Wing
- Zamus Thunder
- X-Star
- S-Wing
- A-Wing
- Standard
- Copper-Mate
- Gra-Mate

▶ 적용 피삭재

○ : 적합 ◎ : 매우 적합

H		P			K	N			M	S
열처리강		탄소강	합금강	프리하든강	주철	동	흑연	알루미늄	스테인리스	내열합금
SKD61 ~HRc55	SKD11 HRc55~	~HB225	HB225 ~325	HRc30~50	~FCD500					
○		○	◎	◎	○					

USB502 2날 스트레이트 넥 볼 엔드밀

Endmill

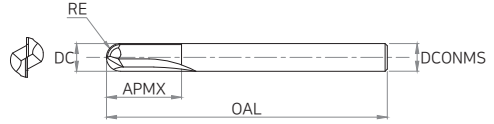
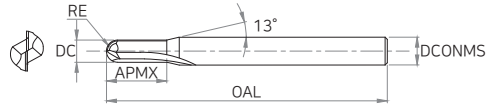

▶ 제품허용공차

날경(DC)		자루경
Ø3 ~ Ø6	0 ~ -0.012	h5
Ø8 ~ Ø20	0 ~ -0.015	



CARBIDE
AlCrN
2
0° HELIX
R ±0.005 R3 이하
R ±0.01 R3 초과
질삭조건 P.705

품목코드	DC	RE	APMX	OAL	DCONMS
	날경	반경 R	날장	전장	자루경
USB502 030	3	1.5	10	70	6
USB502 040	4	2	12	70	6
USB502 050	5	2.5	18	90	6
USB502 060	6	3	20	90	6
USB502 080	8	4	25	100	8
USB502 100	10	5	30	100	10
USB502 120	12	6	32	110	12
USB502 160	16	8	35	150	16
USB502 200	20	10	40	150	20

▶ 적용 피삭재

○ : 적합 ◎ : 매우 적합

H		P			K	N			M	S
열처리강		탄소강	합금강	프리하든강	주철	동	흑연	알루미늄	스테인리스	내열합금
SKD61 ~HRc55	SKD11 HRc55~	~HB225	HB225 ~325	HRc30~50	~FCD500					
○		○	◎	◎	○					

UF50 3~5날 챔퍼 피치 러핑 엔드밀

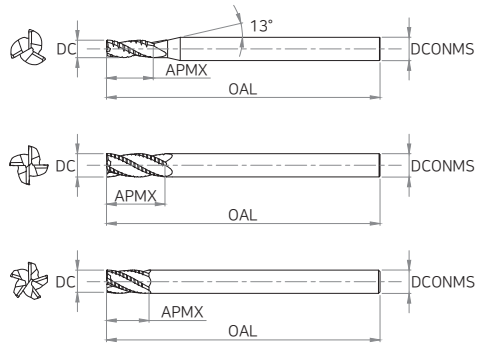

▶ 제품허용공차

날경(DC)		자루경
~ Ø6	0 ~ -0.012	
Ø8 ~ Ø25	0 ~ -0.015	h5

CARBIDE

AlCrN

Chamfered

3~5

29° HELIX

31° HELIX

R ±0.025

절삭조건 P.706

품목코드	DC	RE	APMX	OAL	DCONMS	NOF	품목코드	DC	RE	APMX	OAL	DCONMS	NOF
	날경	Corner R	날장	전장	자루경	날수		날경	Corner R	날장	전장	자루경	날수
UF50 3030	3	0.2	8	50	6	3	UF50 412030	12	0.3	30	80	12	4
UF50 3040	4	0.2	10	50	6	3	UF50 5130	13	0.5	35	100	12	5
UF50 4050	5	0.2	13	50	6	4	UF50 5140S16	14	0.5	35	100	16	5
UF50 4060	6	0.2	10	50	6	4	UF50 5140	14	0.5	35	100	14	5
UF50 406015	6	0.2	15	60	6	4	UF50 5150	15	0.5	35	100	16	5
UF50 4070	7	0.2	18	70	8	4	UF50 5160	16	1	25	80	16	5
UF50 4080	8	0.2	12	60	8	4	UF50 516040	16	1	40	100	16	5
UF50 408020	8	0.2	20	70	8	4	UF50 5180S20	18	1	40	100	20	5
UF50 4090	9	0.3	22	75	10	4	UF50 5180	18	1	40	100	18	5
UF50 4100	10	0.3	15	65	10	4	UF50 5200	20	1	25	80	20	5
UF50 410025	10	0.3	25	75	10	4	UF50 520045	20	1	45	100	20	5
UF50 4110	11	0.3	27	80	12	4	UF50 5250	25	1	45	100	25	5
UF50 4120	12	0.3	20	70	12	4							

▶ 적용 피삭재

○ : 적합 ◎ : 매우 적합

H		P			K	N			M	S
열처리강		탄소강	합금강	프리하든강	주철	동	흑연	알루미늄	스테인리스	내열합금
SKD61 ~HRc55	SKD11 HRc55~	~HB225	HB225 ~325	HRc30~50	~FCD500					
○		○	◎	◎	○					

Endmill
Zamus Star
E-Star
U-Wing
Zamus Thunder
X-Star
S-Wing
A-Wing
Standard
Copper-Mate
Gra-Mate

UF51

3~5날 파인 피치 러핑 엔드밀

Endmill

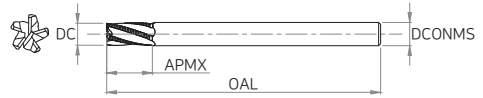
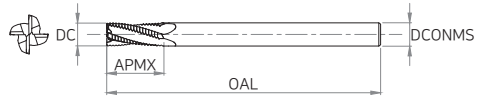
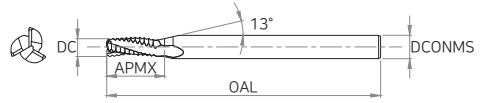

▶ 제품허용공차

날경(DC)		자루경
∅3	0 ~ -0.04	
∅4 ~ ∅6	0 ~ -0.048	
∅7 ~ ∅10	0 ~ -0.058	
∅11 ~ ∅18	0 ~ -0.07	
∅20 ~ ∅25	0 ~ -0.084	

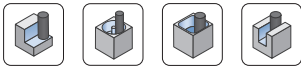

품목코드	DC	APMX	OAL	DCONMS	NOF
	날경	날장	전장	자루경	날수
UF51 3030	3	8	50	6	3
UF51 3040	4	10	50	6	3
UF51 3050	5	13	50	6	3
UF51 3060	6	15	60	6	3
UF51 306020	6	20	60	6	3
UF51 3070	7	18	70	8	3
UF51 3080	8	20	70	8	3
UF51 308025	8	25	70	8	3
UF51 4090	9	22	75	10	4
UF51 4100	10	25	75	10	4
UF51 410030	10	30	75	10	4
UF51 4110	11	27	80	12	4
UF51 4120	12	30	80	12	4
UF51 412035	12	35	80	12	4
UF51 4130	13	35	100	12	4
UF51 4140	14	35	100	16	4
UF51 4160	16	40	100	16	4
UF51 4180	18	40	100	18	4
UF51 4200	20	50	100	20	4
UF51 5250	25	50	100	25	5

▶ 적용 피삭재

○ : 적합 ◎ : 매우 적합

H		P			K	N			M	S
열처리강		탄소강	합금강	프리하든강	주철	동	흑연	알루미늄	스테인리스	내열합금
SKD61 ~HRc55	SKD11 HRc55~	~HB225	HB225 ~325	HRc30~50	~FCD500					
○		○	◎	◎	○					

UF51-H

3-5날 45도 헬릭스 파인 피치 러핑 엔드밀

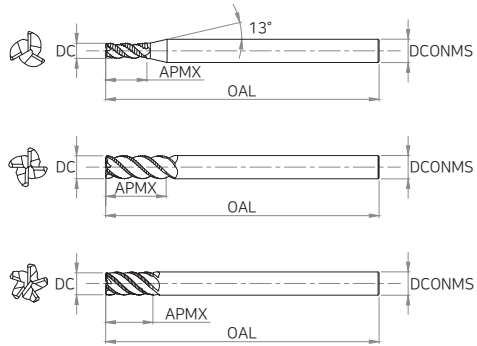

▶ 제품허용공차

날경(DC)		자루경
Ø3 ~ Ø25	0 ~ -0.05	h5

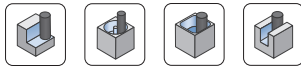

CARBIDE
AlCrN
FINE
3-5
45° HELIX
절삭조건 P.707

품목코드	DC	APMX	OAL	DCONMS	NOF
	날경	날장	전장	자루경	날수
UF51 3030H	3	8	50	6	3
UF51 3040H	4	10	50	6	3
UF51 4050H	5	13	50	6	4
UF51 4060H	6	10	50	6	4
UF51 406015H	6	15	60	6	4
UF51 4070H	7	18	70	8	4
UF51 4080H	8	12	60	8	4
UF51 408020H	8	20	70	8	4
UF51 4090H	9	22	75	10	4
UF51 4100H	10	15	65	10	4
UF51 410025H	10	25	75	10	4
UF51 4110H	11	27	80	12	4

품목코드	DC	APMX	OAL	DCONMS	NOF
	날경	날장	전장	자루경	날수
UF51 4120H	12	20	70	12	4
UF51 412030H	12	30	80	12	4
UF51 5130H	13	35	100	12	5
UF51 5140S16H	14	35	100	16	5
UF51 5140H	14	35	100	14	5
UF51 5160H	16	25	80	16	5
UF51 516040H	16	40	100	16	5
UF51 5180S20H	18	40	100	20	5
UF51 5180H	18	40	100	18	5
UF51 5200H	20	25	80	20	5
UF51 520045H	20	45	100	20	5
UF51 5250H	25	45	100	25	5

▶ 적용 피삭재

○ : 적합 ◎ : 매우 적합

H		P			K	N			M	S
열처리강		탄소강	합금강	프리하든강	주철	동	흑연	알루미늄	스테인리스	내열합금
SKD61 ~HRC55	SKD11 HRC55~	~HB225	HB225 ~325	HRC30~50	~FCD500					
○		○	◎	◎	○					

Endmill

Zamus Star

E-Star

U-Wing

Zamus Thunder

X-Star

S-Wing

A-Wing

Standard

Copper-Mate

Gra-Mate